

The Project Gutenberg EBook of On Riemann's Theory of Algebraic Functions and their Integrals, by Felix Klein

This eBook is for the use of anyone anywhere at no cost and with almost no restrictions whatsoever. You may copy it, give it away or re-use it under the terms of the Project Gutenberg License included with this eBook or online at www.gutenberg.org

Title: On Riemann's Theory of Algebraic Functions and their Integrals
A Supplement to the Usual Treatises

Author: Felix Klein

Translator: Frances Hardcastle

Release Date: August 3, 2011 [EBook #36959]

Language: English

Character set encoding: ISO-8859-1

*** START OF THIS PROJECT GUTENBERG EBOOK ON RIEMANN'S THEORY ***

Produced by Andrew D. Hwang

TRANSCRIBER'S NOTE

The camera-quality files for this public-domain ebook may be downloaded *gratis* at

www.gutenberg.org/ebooks/36959.

This ebook was produced using scanned images and OCR text generously provided by the University of Toronto Gerstein Library through the Internet Archive.

Minor typographical corrections and presentational changes have been made without comment.

This PDF file is optimized for screen viewing, but may be recompiled for printing. Please consult the preamble of the \LaTeX source file for instructions and other particulars.

ON RIEMANN'S THEORY
OF
ALGEBRAIC FUNCTIONS
AND THEIR
INTEGRALS.

A SUPPLEMENT TO THE USUAL TREATISES.

BY
FELIX KLEIN.

TRANSLATED FROM THE GERMAN, WITH THE AUTHOR'S
PERMISSION,

BY
FRANCES HARDCASTLE,
GIRTON COLLEGE, CAMBRIDGE.

Cambridge:
MACMILLAN AND BOWES.
1893

Cambridge:

PRINTED BY C. J. CLAY, M.A. & SONS,
AT THE UNIVERSITY PRESS.

TRANSLATOR'S NOTE.

THE aim of this translation is to reproduce, as far as possible, the ideas and style of the original in idiomatic English, rather than to give a literal rendering of its contents. Even the verbal deviations, however, are few in number. So little has been written in English on the subject that a standard set of technical terms as yet hardly exists. Where there was any choice between equivalent words, I have followed the usage of Dr Forsyth in his recently published work on the Theory of Functions. A [Glossary](#) of the principal technical terms is appended, giving the original German word together with the English adopted in the text.

Prof. Klein had originally intended to revise the proofs, but owing to his absence in America he kindly waived his right to do so, in order not to delay the publication. The proofs have therefore not been submitted to him, though it was with considerable reluctance that I determined to publish without this final revision.

My thanks are due to Miss C. A. Scott, D.Sc., Professor of Mathematics in Bryn Mawr College, for many valuable suggestions in difficult passages and for her interest in the progress of the translation, and also for help in the reading of the proof-sheets. I must also express my thanks to Mr James Harkness, M.A., Associate Professor of Mathematics in Bryn Mawr College, for helpful advice given from time to time; and to Miss P. G. Fawcett, of Newnham College, Cambridge, for reading over in manuscript the earlier parts which deal more especially

with the subject of Electricity.

FRANCES HARDCASTLE.

BRYN MAWR COLLEGE,
PENNSYLVANIA,
June 1, 1893.

CONTENTS.

PART I.

INTRODUCTORY REMARKS.

SECT.	PAGE
1. Steady Streamings in the Plane as an Interpretation of the Functions of $x + iy$	1
2. Consideration of the Infinities of $w = f(z)$	6
3. Rational Functions and their Integrals. Infinities of higher Order derived from those of lower Order. ...	12
4. Experimental Production of these Streamings.	16
5. Transition to the Surface of a Sphere. Streamings on arbitrary curved Surfaces.	20
6. Connection between the foregoing Theory and the Functions of a complex Argument.....	25
7. Streamings on the Sphere resumed. Riemann's general Problem.	29

PART II.

RIEMANN'S THEORY.

SECT.	PAGE
8. Classification of closed Surfaces according to the Value of the Integer p	31
9. Preliminary Determination of steady Streamings on arbitrary Surfaces.....	35
10. The most general steady Streaming. Proof of the Impossibility of other Streamings.....	40
11. Illustration of the Streamings by means of Examples... ..	43
12. On the Composition of the most general Function of Position from single Summands.....	50
13. On the Multiformity of the Functions. Special Treatment of uniform Functions.....	54
14. The ordinary Riemann's Surfaces over the $x + iy$ Plane. . .	59
15. The Anchor-ring, $p = 1$, and the two-sheeted Surface over the Plane with four Branch-points.....	62
16. Functions of $x + iy$ which correspond to the Streamings already investigated.....	70
17. Scope and Significance of the previous Investigations... ..	74
18. Extension of the Theory.	77

PART III.

CONCLUSIONS.

19. On the Moduli of Algebraical Equations.	80
--	----

SECT.	PAGE
20. Conformed Representation of closed Surfaces upon themselves.....	86
21. Special Treatment of symmetrical Surfaces.....	90
22. Conformal Representation of different closed Surfaces upon each other.	96
23. Surfaces with Boundaries and unifacial Surfaces.....	98
24. Conclusion.....	102

PREFACE.

THE pamphlet which I here lay before the public, has grown from lectures delivered during the past year,* in which, among other objects, I had in view a presentation of Riemann's theory of algebraic functions and their integrals.† Lectures on higher mathematics offer peculiar difficulties; with the best will of the lecturer they ultimately fulfil a very modest purpose. Being usually intended to give a *systematic* development of the subject, they are either confined to the elements or are lost amid details. I thought it well in this case, as previously in others, to adopt the opposite course. I assumed that the ordinary presentation, as given in text-books on the elements of Riemann's theory, was known; moreover, when particular points required to be more fully dealt with, I referred to the fundamental monographs. But to compensate for this, I devoted great care to the presentation of the *true train of thought*, and endeavoured to obtain a *general view* of the scope and efficiency of the methods. I believe I have frequently obtained good results by these means, though, of course, only with a gifted audience; experience will show whether this pamphlet,

* *Theory of Functions treated geometrically*. Part I, Winter-semester 1880–81, Part II, Summer-semester 1881.

† I denote thus the contents of the investigations with which Riemann was concerned in the first part of his *Theory of the Abelian Functions*. The theory of the Θ -functions, as developed in the second part of the same treatise, is in the first place, as we know, of an essentially different character, and is excluded from the following presentation as it was from my course of lectures.

based on the same principles, will prove equally useful.

A presentation of the kind attempted is necessarily very subjective, and the more so in the case of Riemann's theory, since but scanty material for the purpose is to be found explicitly given in Riemann's papers. I am not sure that I should ever have reached a well-defined conception of the whole subject, had not Herr Prym, many years ago (1874), in the course of an opportune conversation, made me a communication which has increased in importance to me the longer I have thought over the matter. He told me that *Riemann's surfaces originally are not necessarily many-sheeted surfaces over the plane, but that, on the contrary, complex functions of position can be studied on arbitrarily given curved surfaces in exactly the same way as on the surfaces over the plane.* The following presentation will sufficiently show how valuable this remark has been to me. In natural combination with this there are certain physical considerations which have been lately developed, although restricted to simpler cases, from various points of view.* I have not hesitated to take these physical conceptions as the starting-point of my presentation. Riemann, as we know, used Dirichlet's Principle in their place in his writings. But I have no doubt that he started from precisely those physical problems, and then, in order to give what was physically evident the support of mathematical reasoning, he afterwards substituted Dirichlet's Principle. Anyone who clearly

*Cf. C. Neumann, *Math. Ann.*, t. x., pp. 569–571. Kirchhoff, *Berl. Monatsber.*, 1875, pp. 487–497. Töpler, *Pogg. Ann.*, t. CLX., pp. 375–388.

understands the conditions under which Riemann worked in Göttingen, anyone who has followed Riemann's speculations as they have come down to us, partly in fragments,* will, I think, share my opinion.—However that may be, the physical method seemed the true one for my purpose. For it is well known that Dirichlet's Principle is not sufficient for the actual foundation of the theorems to be established; moreover, the heuristic element, which to me was all-important, is brought out far more prominently by the physical method. Hence the constant introduction of intuitive considerations, where a proof by analysis would not have been difficult and might have been simpler, hence also the repeated illustration of general results by examples and figures.

In this connection I must not omit to mention an important restriction to which I have adhered in the following pages. We all know the circuitous and difficult considerations by which, of late years, part at least of those theorems of Riemann which are here dealt with have been proved in a reliable manner.† These considerations are entirely neglected in what follows and I thus forego the use of any except intuitive bases for the the-

* *Ges. Werke*, pp. 494 *et seq.*

† Compare in particular the investigations on this subject by C. Neumann and Schwarz. The general case of *closed* surfaces (which is the most important for us in what follows) is indeed, as yet, nowhere explicitly and completely dealt with. Herr Schwarz contents himself with a few indications with respect to these surfaces (*Berl. Monatsber.*, 1870, pp. 767 *et seq.*) and Herr C. Neumann only considers those cases in which functions are to be determined by means of known values on the boundary.

orems to be enunciated. In fact such proofs must in no way be mixed up with the sequence of thought I have attempted to preserve; otherwise the result is a presentation unsatisfactory from all points of view. But they should assuredly follow after, and I hope, when opportunity offers, to complete in this sense the present pamphlet.

For the rest, the scope and limits of my presentation speak for themselves. The frequent use of my friends' publications and of my own on kindred subjects had a secondary purpose important to me for personal reasons: I wished to give my audience a guide, to help them to find for themselves the reciprocal connections among these papers, and their position with respect to the general conception put forth in these pages. As for the *new* problems which offer themselves in great number, I have only allowed myself to investigate them as far as seemed consistent with the general aim of this pamphlet. Nevertheless I should like to draw attention to the theorems on the conformal representation of arbitrary surfaces which I have worked out in the last Part; I followed these out the more readily that Riemann makes a remarkable statement about this subject at the end of his Dissertation.

One more remark in conclusion to obviate a misunderstanding which might otherwise arise from the foregoing words. Although I have attempted, in the case of algebraic functions and their integrals, to follow the original chain of ideas which I assumed to be Riemann's, I by no means include the whole of what he intended in the theory of functions. The said functions were for him an example only, in the treatment of which, it is

true, he was particularly fortunate. Inasmuch as he wished to include all possible functions of complex variables, he had in mind far more general methods of determination than those we employ in the following pages; methods of determination in which physical analogy, here deemed a sufficient basis, fails us. Compare, in this connection, § 19 of his Dissertation, compare also his work on the hypergeometrical series.—With reference to this, I must explain that I have no wish to draw aside from these more general considerations by giving a presentation of a special part, complete in itself. My innermost conviction rather is that they are destined to play, in the developments of the modern Theory of Functions, an important and prominent part.

BORKUM,

Oct. 7, 1881.

PART I.

INTRODUCTORY REMARKS.

§ 1. *Steady Streamings in the Plane as an Interpretation of the Functions of $x + iy$.*

The physical interpretation of those functions of $x + iy$ which are dealt with in the following pages is well known.* The principles on which it is based are here indicated, solely for completeness.

Let $w = u + iv$, $z = x + iy$, $w = f(z)$. Then we have, primarily,

$$(1) \quad \frac{\partial u}{\partial x} = \frac{\partial v}{\partial y}, \quad \frac{\partial u}{\partial y} = -\frac{\partial v}{\partial x},$$

and hence

$$(2) \quad \frac{\partial^2 u}{\partial x^2} + \frac{\partial^2 u}{\partial y^2} = 0,$$

and also, for v ,

$$(3) \quad \frac{\partial^2 v}{\partial x^2} + \frac{\partial^2 v}{\partial y^2} = 0.$$

*In particular, reference should be made to Maxwell's *Treatise on Electricity and Magnetism* (Cambridge, 1873). So far as the intuitive treatment of the subject is concerned, his point of view is exactly that adopted in the text.

In these equations we take u to be the *velocity-potential*, so that $\frac{\partial u}{\partial x}$, $\frac{\partial u}{\partial y}$ are the components of the velocity of a fluid moving parallel to the xy plane. We may either suppose this fluid to be contained between two planes, parallel to the xy plane, or we may imagine it to be itself an infinitely thin homogeneous sheet extending over this plane. Then equation (2)—and this is the chief point in the physical interpretation—shows that the streaming is *steady*. The curves $u = \text{const.}$ are called the *equipotential curves*, while the curves $v = \text{const.}$, which, by (1), are orthogonal to the first system, are the *stream-lines*. For the purposes of this interpretation it is of course indifferent of what nature we may imagine the fluid to be, but for many reasons it will be convenient to identify it here with the *electric fluid*; u is then proportional to the electrostatic potential which gives rise to the streaming, and the apparatus of experimental physics provide sufficient means for the production of many interesting systems of streamings.

Moreover, if we increase u throughout by a constant the streaming itself remains unchanged, since the differential coefficients $\frac{\partial u}{\partial x}$, $\frac{\partial u}{\partial y}$ alone appear explicitly; this is also true of v . Hence the function $u + iv$, whose physical interpretation is in question, is thus determined only to an additive constant *près*, a fact which requires to be carefully observed in what follows.

Further, we may observe that equations (1)–(3) remain unaltered if we replace u by v , and v by $-u$. Corresponding to this we get a second system of streamings in which v is the

velocity-potential and the curves $u = \text{const.}$ are the stream-lines; in the sense explained above this represents the function $v - iu$. It is often of use to consider this new streaming as well as the original one in which u was the velocity-potential; we shall speak of it, for brevity, as the *conjugate* streaming. It is true that the name is somewhat inaccurate, since u bears the same relation to v , as v does to $-u$, but it is sufficiently intelligible for our purpose.

The differential equations (1)–(3), and hence also the whole preceding discussion, apply in the first place solely to that portion of the plane (otherwise an arbitrary portion) in which $u + iv$ is **uniform** and in which neither $u + iv$ nor its differential coefficients become infinite. In order then that the corresponding physical conditions maybe clearly comprehended, a region of this kind must be marked off and then by suitable appliances on the boundary the steady motion within its limits must be preserved.

In a bounded region of this description points z_0 at which the differential coefficient $\frac{\partial w}{\partial z}$ vanishes call for special attention To be perfectly general, I will assume at once that $\frac{\partial^2 w}{\partial z^2}$, $\frac{\partial^3 w}{\partial z^3}$, \dots , up to $\frac{\partial^\alpha w}{\partial z^\alpha}$ are all zero as well. To determine the course of the equipotential curves, or of the stream-lines in the vicinity of such a point, let w be expanded in a series of ascending powers of $z - z_0$; in this series, the term immediately after the constant term is the term in $(z - z_0)^{\alpha+1}$. Transform-

ing to polar-coordinates we obtain the following result: *at the point z_0 , $\alpha+1$ curves $u = \text{const.}$ intersect at equal angles, while the same number of curves $v = \text{const.}$ are the bisectors of these angles.* In consequence of this property I call such a point a *cross-point*, and moreover a *cross-point of multiplicity α* .

The following figure (which is of course only diagrammatic) illustrates this for $\alpha = 2$, and explains, in particular, how a cross-point makes its appearance in the orthogonal system

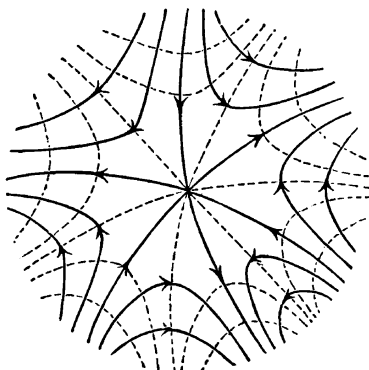

Fig. 1.

formed by the curves $u = \text{const.}$, $v = \text{const.}$

The stream-lines $v = \text{const.}$ are the heavy lines in the figure and the direction of motion in each is indicated by an arrow; the equipotential curves are given by dotted lines. We see how the fluid flows in towards the cross-point from three directions, and flows out again in three other directions, this being possible because the velocity of the streaming is zero

at the cross-point, or, as we may say, by analogy with known occurrences, because the fluid is at a standstill, the expression for the velocity being $\sqrt{\left(\frac{\partial u}{\partial x}\right)^2 + \left(\frac{\partial u}{\partial y}\right)^2}$.

Further, it is useful to consider a cross-point of multiplicity α as *the limiting case of α simple cross-points*. The analytical treatment shows this to be permissible. For at an α -ple cross-point the equation $\frac{\partial w}{\partial z} = 0$ has an α -ple root and this is caused, as we know, by the coalescence of α simple roots. The following figures sufficiently explain this view:

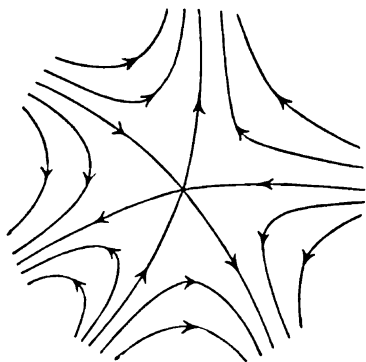

Fig. 2.

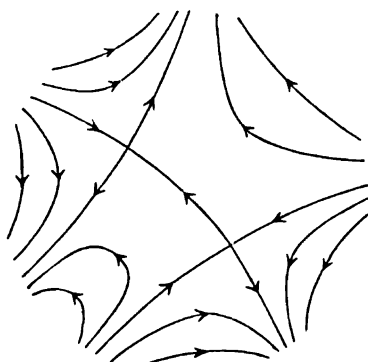

Fig. 3.

For simplicity, I have here drawn the stream-lines only. On the left we have the same cross-point of multiplicity two as in Fig. 1; on the right we have a streaming with two simple cross-points close together. It is at once evident that the one figure is produced by continuous changes from the other.

Throughout the foregoing discussion it has been tacitly assumed that the region in question does not extend to infinity. It is true that no fundamental difficulties present themselves when we take the point $z = \infty$ into account exactly as we take any other point $z = z_0$; instead of the expansion in ascending powers of $z - z_0$, we obtain, by known methods, an expansion in ascending powers of $\frac{1}{z}$; there is an α -ple cross-point at $z = \infty$ when the term immediately following the constant term in this expansion is the term in $\left(\frac{1}{z}\right)^{\alpha+1}$. But we need dwell no further on the geometrical relations corresponding to a streaming of this kind, for the separate treatment of $z = \infty$, which here presents itself, will be obviated once and for all by a method to be explained shortly, and for this reason the point $z = \infty$ will be left out of consideration in the following sections (§§ 2–4), although, if a complete treatment were desired, it ought to be specially mentioned.

§ 2. *Consideration of the Infinities of $w = f(z)$.*

We now further include in this region points z_0 at which $w = f(z)$ becomes infinite. But, since we are about to consider only a special class of functions, we restrict ourselves in this direction by the following condition, viz.: *the differential coefficient $\frac{\partial w}{\partial z}$ must have no essential singularities*, or, in other words, *w is to be infinite only in the same manner as an*

expression of the following form:

$$A \log(z - z_0) + \frac{A_1}{z - z_0} + \frac{A_2}{(z - z_0)^2} + \dots + \frac{A_\nu}{(z - z_0)^\nu},$$

in which ν is a determinate finite quantity.

Corresponding to the various forms which this expression assumes, we say that at $z = z_0$ different discontinuities are superposed; a *logarithmic* infinity, an *algebraic* infinity of order one, etc. For simplicity we here consider each separately, but it is also a useful exercise to form a clear idea of the result of the superposition in individual examples.

In the first instance, let $z = z_0$ be a *logarithmic* infinity; we then have:

$$w = A \log(z - z_0) + C_0 + C_1(z - z_0) + C_2(z - z_0)^2 + \dots$$

Here A is that quantity which when multiplied by $2i\pi$ is called, in Cauchy's notation, the *residue* of the logarithmic infinity, a term which will be occasionally employed in what follows. In the investigation of a streaming in the vicinity of the discontinuity it is of primary importance to know whether A is real, imaginary, or complex. The third case can obviously be regarded as a superposition of the first two and may therefore be neglected. There are then only two distinct possibilities to be considered.

(1) If A is real, let $C_0 = a + ib$. Then, to a first approximation, we have, writing $w = u + iv$, $z - z_0 = re^{i\phi}$,

$$u = A \log r + a, \quad v = a\phi + b.$$

Thus the curves $u = \text{const.}$ are small circles round the infinity, and the curves $v = \text{const.}$ radiate from it in all directions according to the variable values of ϕ . *The motion is such that $z = z_0$ is a source of a certain positive or negative strength.* To calculate this strength, multiply the element of arc of a small circle described about the discontinuity with radius r , by the proper velocity and integrate this expression round the circle. Since

$$\sqrt{\left(\frac{\partial u}{\partial x}\right)^2 + \left(\frac{\partial u}{\partial y}\right)^2}$$

coincides to a first approximation with $\frac{\partial u}{\partial r}$, that is with $\frac{A}{r}$, we obtain for the strength the expression

$$\int_0^{2\pi} \frac{A}{r} r d\phi = 2A\pi.$$

The strength is therefore equal to the residue, divided by i ; it is positive or negative with A .

(2) Let A be purely imaginary, equal to iA . Then, with the same notation as before, we have to a first approximation,

$$u = -A\phi + b, \quad v = A \log r + b.$$

The parts played by the curves $u = \text{const.}$, $v = \text{const.}$ are thus exactly interchanged; the equipotential curves now radiate from $z = z_0$, while the stream-lines are small circles round the infinity. The fluid circulates in these curves round the point $z = z_0$; I call the point a *vortex-point* for this reason.

The sense and intensity of the **circulation** are measured by A . Since the velocity

$$\sqrt{\left(\frac{\partial u}{\partial x}\right)^2 + \left(\frac{\partial u}{\partial y}\right)^2}$$

is, to a first approximation, equal to $\frac{\partial u}{\partial \phi}$, *the circulation is clockwise or counter-clockwise according as A is positive or negative*. We may call the intensity of the vortex-point $2A\pi$, it is then equal and opposite to the residue of the infinity in question.

Further, bearing in mind the definition in the last section of a conjugate streaming and the ambiguity of sign attached to it, we may say: *If one of two conjugate streamings has a source of a certain strength at $z = z_0$, the other has, at the same point, a vortex-point of equal, or equal and opposite, intensity*.

Next, consider *algebraic* discontinuities. The general character of the streaming is independent of the nature of the coefficient of the first term of the power-series, be it real, imaginary or complex. Let

$$w = \frac{A_1}{z - z_0} + C_0 + C_1(z - z_0) + \dots$$

To a first approximation, writing

$$z - z_0 = re^{i\phi}, \quad A_1 = \rho e^{i\psi},$$

$$w - C_0 = \frac{\rho}{r} \{ \cos(\psi - \phi) + i \sin(\psi - \phi) \}.$$

Let us first consider the real part on the right. When r is very small, $\frac{\rho}{r} \cos(\psi - \phi)$ may still, by proper choice of ϕ be made to assume any given arbitrary value; *the function u therefore assumes every value in the immediate vicinity of the discontinuity.* For more exact determination, let us, for the moment, consider r and ϕ as variables and write

$$\frac{\rho}{r} \cos(\psi - \phi) = \text{const.}$$

We obtain a pencil of circles, all touching the fixed line

$$\phi = \psi + \frac{\pi}{2}$$

and becoming smaller as the **modulus** of the constant increases. *Then, in the vicinity of the discontinuity, the curves $u = \text{const.}$ are of a similar description, and, in particular, for very large positive or negative values of the constant they take the form of small, closed, simple ovals.*

A similar discussion applies to the imaginary part on the right and hence to the curves $v = \text{const.}$, but the line touched by all the curves in this case is $\phi = \psi$. The following figure, in which the equipotential curves are, as before, dotted lines and the stream-lines heavy lines, will now be intelligible.

An analogous discussion gives the requisite graphic representation of a ν -ple algebraic discontinuity. It is sufficient merely to state the result: *Every curve $u = \text{const.}$ passes ν times through the discontinuity and touches ν fixed tangents, intersecting at equal angles. Similarly with the curves*

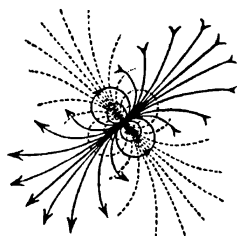

Fig. 4.

$v = \text{const.}$ For very great positive or negative values of the constant both systems of curves are closed in the immediate

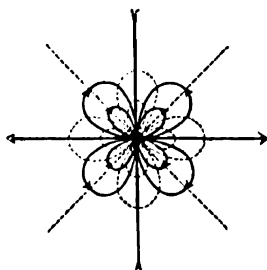

Fig. 5.

vicinity of the discontinuity. For illustration the figure is given for $\nu = 2$.

These higher singularities, as may be surmised, can be derived from those of lower order by proceeding to the limit. I postpone this discussion, however, to the next section, since a

certain class of functions will then easily supply the necessary examples.

§ 3. *Rational Functions and their Integrals. Infinities of higher Order derived from those of lower Order.*

The foregoing sections have enabled us to picture to ourselves the whole course of such functions as have no infinities other than those we have just considered and are with these exceptions *uniform* over the whole plane. These are, as we know, *the rational functions and their integrals*. I briefly state, without figures, the theorems respecting the cross-points and infinities of these functions, and, for reasons already stated, I confine myself to the cases in which $z = \infty$ is not a critical point. This limitation, as was before pointed out, will afterwards disappear automatically.

(1) The rational function about to be considered presents itself in the form

$$w = \frac{\phi(z)}{\psi(z)},$$

where ϕ and ψ are integral functions of the same order which may be assumed to have no common factor. If this order is n , and if every algebraic infinity is counted as often as its order requires, we obtain, corresponding to the roots of $\psi = 0$, n algebraic discontinuities. The cross-points are given by $\psi\phi' - \psi'\phi = 0$, an equation of degree $2n - 2$. *The sum of the orders of the cross-points is then $2n - 2$* , where, however, it must be noticed that every ν -fold root of $\psi = 0$ is a $(\nu - 1)$ -

fold root of $\psi' = 0$, and hence that every ν -fold infinity of the function counts as a $(\nu - 1)$ -fold cross-point.

(2) If the integral of a rational function

$$W = \int \frac{\Phi(z)}{\Psi(z)} dz$$

is to be finite at $z = \infty$, the degree of Φ must be less by two than that of Ψ . It is assumed that Φ and Ψ have no common factor. Then $\Phi = 0$ gives the *free cross-points*, *i.e.* those which do not coincide with infinities. The roots of $\Psi = 0$ give the infinities of the integral; and, moreover, to a simple root of $\Psi = 0$ corresponds a logarithmic infinity, to a double root an infinity which is, in general, due to the superposition of a logarithmic discontinuity and a simple algebraic discontinuity, etc. *If then every infinity is counted as often as the order of the corresponding factor in Ψ requires, the sum of the orders of the cross-points is less by two than the sum of the orders of the infinities.* We must also draw attention to the known theorem, that the sum of the logarithmic residues of all the discontinuities is zero.

The foregoing gives two possible methods for the derivation of discontinuities of higher order from those of lower order. First—and this is the more important method for our purpose—we may start from the integrals of rational functions. In this case an algebraic discontinuity of order ν makes its appearance when $\nu + 1$ factors of Ψ become equal, that is, *when $\nu + 1$ logarithmic discontinuities coalesce in the proper manner.* It is clear that the sum of the residues of the latter

must be zero, if the resulting infinity is to be purely algebraic. The two following figures, in which only the stream-lines are drawn, show how to proceed to the limit in the case of the simple algebraic discontinuity of Fig. 4.

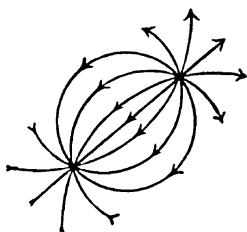

Fig. 6.

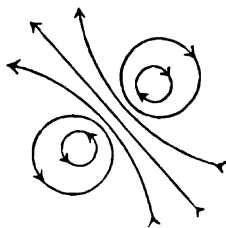

Fig. 7.

Two different processes are here indicated; in the left-hand figure two sources are about to coalesce, while in the right-hand figure these are replaced by vortex-points. Fig. 4 is the resulting limiting position after either process. The two following figures bear the corresponding relation to Fig. 5.

The second possible method is suggested by considering the rational function $\frac{\phi}{\psi}$ itself. Logarithmic discontinuities are thereby excluded. *The ν -fold algebraic discontinuity now arises from ν simple algebraic discontinuities, for ν simple linear factors of ψ in coalescing form a ν -fold factor. But at the same time a number of cross-points coalesce and the sum of their orders is $\nu - 1$.* For $\psi\phi' - \phi\psi' = 0$ has, as was pointed out before, a $(\nu - 1)$ -fold factor at the same instant that a ν -fold factor appears in ψ . The following figure explains the produc-

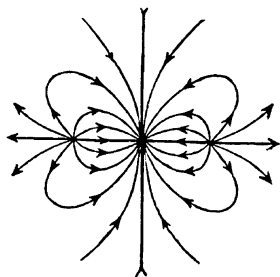

Fig. 8.

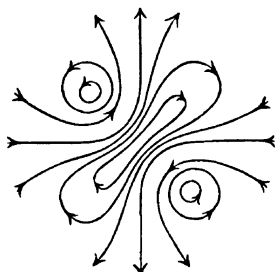

Fig. 9.

tion by this method of the two-fold algebraic discontinuity of Fig. 5.

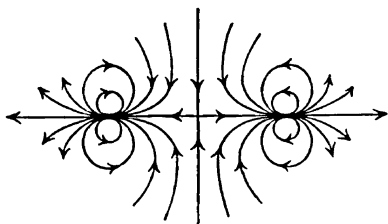

Fig. 10.

It is of course easy to include these two methods of proceeding to the limit in one common and more general method. If $\nu + \mu + 1$ logarithmic infinities and μ cross-points coalesce successively or simultaneously, a ν -fold algebraic discontinuity will in every case make its appearance. But this is not the place to enlarge on the idea thus suggested.

§ 4. *Experimental Production of these Streamings.*

We now give a different direction to our investigations and consider how to bring about the physical production of those states of motion which are associated, as we have just seen, with rational functions and their integrals. Let it be assumed that the principle of *superposition* may be freely used, so that we need only consider the simplest cases. From the theory of partial fractions it follows that each of the functions in question can be compounded additively of single parts, which fall under one of the two following types:

$$A \log(z - z_0), \quad \frac{A}{(z - z_0)^\nu}.$$

But since $\log(z - z_0)$ is discontinuous at $z = \infty$, the first type is unnecessarily specialised, and may be replaced by the more general one

$$A \log \frac{z - z_0}{z - z_1},$$

and this again, as in § 2, may be divided into two parts—viz.: writing $A = A + iB$, we discuss $A \log \frac{z - z_0}{z - z_1}$ and $iB \log \frac{z - z_0}{z - z_1}$ separately. Hence there are in all three cases to be distinguished.

(1) Corresponding to the type $A \log \frac{z - z_0}{z - z_1}$ a source of strength $2A\pi$ must be produced at z_0 , and one of strength $-2A\pi$ at z_1 . To effect this, conceive the xy plane to be covered with an infinitely thin, homogeneous conducting film. Then it

is clear that the required state of motion will be produced *by placing the two poles of a galvanic battery of proper strength at z_0 and z_1 .** The reason that the residue of z_0 must be equal and opposite to that of z_1 is now at once evident: the streaming is to be steady, hence the amount of electricity flowing in at one point must be equal to that flowing out at the other. There is obviously an analogous reason for the corresponding theorem concerning any number of logarithmic infinities, but applying in the first place only to the purely imaginary parts of the respective residues (these being associated with sources at the infinities).

(2) In the second case, where $iB \log \frac{z - z_0}{z - z_1}$ is given, the experimental construction is rather more difficult. The simplest arrangement is to join z_0 to z_1 by a simple arc of a curve and make this the seat of a constant electromotive force. A streaming is then set up in the xy plane with vortex-points at z_0, z_1 , but otherwise continuous, and from this, by integration, we obtain as velocity-potential a function whose value is increased by a certain modulus of periodicity for every circuit round z_0 or z_1 . We must carefully distinguish between this velocity-potential and the necessarily one-valued electrostatic potential. The curve joining z_0 to z_1 is a curve of discontinuity for the latter, and this very fact makes the electrostatic potential one-valued.†

*See Kirchhoff's fundamental memoir: "Ueber den Durchgang eines elektrischen Stromes durch eine Ebene," *Pogg. Ann.* t. LXIV. (1845).

†The statements in the text are intimately connected, as we know,

I cannot say whether there are any experimental means of producing this simplest arrangement. It would appear that we must go to work in a more roundabout way. Let us first think of thermo-electric currents. Let the xy plane be covered, partly with material I, partly with material II, and let the strength of the films be so arranged that the conductivity shall be everywhere the same. If we now contrive that the two parts of the contour separated by z_0 and z_1 may be kept at constant and different temperatures, an electric streaming of the kind required will be set up. And the electrostatic potential, by the principles of the theory of thermo-electricity, exhibits discontinuities on *both* parts of the said contour. It would apparently be still more complicated to use electric currents produced by the ordinary galvanic elements. The plane must then be divided by at least three curves drawn from z_0 to z_1 , and two of these parts must be covered by a metallic film, the other by a conducting liquid film. See [Fig. 12](#).

In all these constructions it is clear, *ab initio*, that the vortex-points at z_0 and z_1 must have equal and opposite intensities. For similar reasons the total intensity of all the vortex-points must always be zero, and thus the theorem that the sum of the logarithmic residues must vanish has been placed on a physically evident basis as regards the real, as well as the

with the theory of "*Doppelbelegungen*" for which cf. Helmholtz, *Pogg. Ann.* (1853) t. LXXXIX. pp. 224 *et seq.* (*Ueber einige Gesetze der Vertheilung elektrischer Ströme in körperlichen Leitern*), and C. Neumann's treatise *Untersuchungen über das Logarithmische und Newton'sche Potential* (Leipzig, Teubner, 1877).

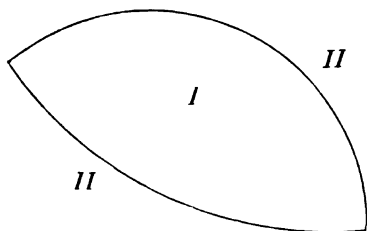

Fig. 11.

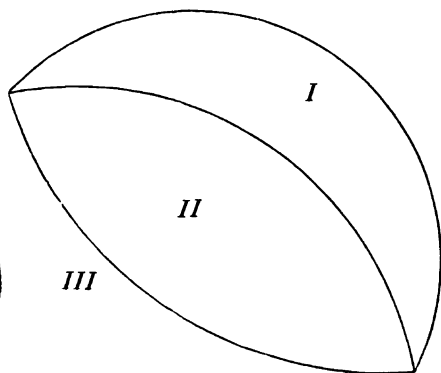

Fig. 12.

imaginary, parts of these residues.

(3) The states of motion associated with the algebraic types $\frac{A}{(z - z_0)^\nu}$ can, by the results of § 3, be derived from those just established, by proceeding to the limit. This is, of course, only possible to a certain degree of approximation. For example, let $\nu + 1$ wires, connected with the poles of a galvanic battery, be placed *close together* on the xy plane. Then a streaming is set up which at a little distance from the ends of the wires sensibly resembles that associated with an algebraic discontinuity of multiplicity ν . At the same time an additional fact in connection with the above construction is brought to light. The galvanic battery must be *very strong* if an electric streaming of even medium strength is to be originated. This corresponds to the well-known analytical theorem that the residues of the logarithmic infinities must increase to an infinite degree in order

that the conjunction of logarithmic discontinuities may lead to an algebraic discontinuity. No further details need be here given as it is only necessary for what follows that the general principles should be grasped by means of Figs. 6–9.

§ 5. *Transition to the Surface of a Sphere. Streamings on arbitrary curved Surfaces.*

To extend the treatment of finite values of z to infinitely great values, the use of the surface of a sphere* derived from the xy plane by stereographic projection is now adopted in all text-books. The simple geometrical relations involved in this representation are known,† and we are also perfectly familiar

*Following the example of C. Neumann, *Vorlesungen über Riemann's Theorie der Abel'schen Integrale*, Leipzig, 1865.—The introduction of the sphere is, so to speak, parallel to the substitution for z of the ratio $\frac{z_1}{z_2}$ of two variables, whereby the treatment of infinitely great values of z is, as we know, *formally* included in that of the finite values.

†If ξ, η, ζ are rectangular coordinates, let the equation of the sphere be $\xi^2 + \eta^2 + (\zeta - \frac{1}{2})^2 = \frac{1}{4}$. Project from the point $\xi = 0, \eta = 0, \zeta = 1$, let the plane of projection be the xy plane, and the opposite tangent-plane the $\xi\eta$ plane. Then we have

$$\xi = \frac{x}{x^2 + y^2 + 1}, \quad \eta = \frac{y}{x^2 + y^2 + 1}, \quad \zeta = \frac{1}{x^2 + y^2 + 1}.$$

If ds is the element of arc on the plane, $d\sigma$ that corresponding to it on the sphere, we have

$$d\sigma = \frac{ds}{x^2 + y^2 + 1},$$

with the fact that the infinitely distant parts of the plane are drawn together to one point of the sphere, the point from which we project, so that it is no longer merely symbolical to speak of the point $z = \infty$ on the sphere. It appears however to be a matter of far less general knowledge that by means of this representation the functions of $x + iy$ acquire a signification on the sphere exactly analogous to that they had on the plane, and hence, that *in the foregoing sections the sphere may be substituted everywhere for the plane and that thus, from the outset, there is no question of exceptional conditions for the value $z = \infty$.** The propositions of the theory of surfaces from which this statement follows are now briefly set forth in a form sufficiently general to serve for certain future purposes.

In the study of fluid motions parallel to the xy plane we have already had occasion to assume the film of fluid under investigation to be infinitely thin. The general question of fluid motion on any surface may obviously be similarly regarded. An example is afforded by the displacements of fluid-membranes, freely extended in space, over themselves, as may

a formula of great importance hereafter, inasmuch as it indicates the *conformal* character of the representation.

*In connection with this and with the following discussion compare Beltrami, "Delle variabili complesse sopra una superficie qualunque," *Ann. di Mat.* ser. 2, t. 1., pp. 329 *et seq.*—The particular remark that surface-potentials remain such after a conformal transformation is to be found in the treatises cited in the preface, by C. Neumann, Kirchhoff, and Töpler, as well as *e.g.* in Haton de la Goupillière, "Méthodes de transformation en Géométrie et en Physique Mathématique," *Journ. de l'Éc. Poly.* t. xxv. 1867, pp. 169 *et seq.*

be particularly well observed in Plateau's experiments.

We shall attempt to define such states of motion also by a potential and we shall especially enquire what is the case in steady motion.

The proper extension of our conception of a potential presents itself at once. Let u be a function of position on the surface and let the curves $u = \text{const.}$ be drawn; moreover let the direction of fluid-motion on the surface at every point be *perpendicular* to the curve $u = \text{const.}$ passing through that point, and let the velocity be $\frac{\partial u}{\partial n}$, where ∂n is the element of arc drawn on the surface normal to the curve. Then u , as in the plane, is called the velocity-potential.

This streaming, so defined, is now to be *steady*. To be definite, let us make use on the surface of a system of curvilinear coordinates p, q , and let the expression for the element of arc in this system be

$$(1) \quad ds^2 = E dp^2 + 2F dp dq + G dq^2.$$

Then by a few simple steps similar throughout to those usually employed in the plane, we find that if u is to give rise to a steady streaming, it must satisfy the following differential equation of the second order:

$$(2) \quad \frac{\partial \frac{F \frac{\partial u}{\partial q} - G \frac{\partial u}{\partial p}}{\sqrt{EG - F^2}}}{\partial p} + \frac{\partial \frac{F \frac{\partial u}{\partial p} - E \frac{\partial u}{\partial q}}{\sqrt{EG - F^2}}}{\partial q} = 0.$$

A short discussion in connection with this differential equation will now bring out the full analogy with the results for the plane. From the form of (2) it follows that for every u which satisfies (2) another function v can be found having the known reciprocal relation to u . For, by (2), the following equations hold simultaneously:

$$(3) \quad \begin{cases} \frac{\partial v}{\partial p} = \frac{F \frac{\partial u}{\partial p} - E \frac{\partial u}{\partial q}}{\sqrt{EG - F^2}}, \\ \frac{\partial v}{\partial q} = \frac{G \frac{\partial u}{\partial p} - F \frac{\partial u}{\partial q}}{\sqrt{EG - F^2}}; \end{cases}$$

and they define v , save as to a necessarily indeterminate constant. But solving (3) we have

$$(4) \quad \begin{cases} -\frac{\partial u}{\partial p} = \frac{F \frac{\partial v}{\partial p} - E \frac{\partial v}{\partial q}}{\sqrt{EG - F^2}}, \\ -\frac{\partial u}{\partial q} = \frac{G \frac{\partial v}{\partial p} - F \frac{\partial v}{\partial q}}{\sqrt{EG - F^2}}, \end{cases}$$

and hence,

$$(5) \quad \frac{\partial \frac{F \frac{\partial v}{\partial q} - G \frac{\partial v}{\partial p}}{\sqrt{EG - F^2}}}{\partial p} + \frac{\partial \frac{F \frac{\partial v}{\partial p} - E \frac{\partial v}{\partial q}}{\sqrt{EG - F^2}}}{\partial q} = 0,$$

so that, on the one hand, u bears to v the same relation as v to $-u$, and on the other hand v , as well as u , satisfies the partial differential equation (2). At the same time the geometrical meaning of equations (3) and (4) respectively shows that the systems of curves $u = \text{const.}$, $v = \text{const.}$ are in general orthogonal.

As regards the statement at the beginning of this section with respect to the stereographic projection of the sphere on the plane, it follows at once from the fact *that the equations (2)–(5) are homogeneous in E, F, G , and of zero dimensions.** If two surfaces can be mapped conformally upon one another, and if corresponding curvilinear coordinates are employed, the expression for the element of arc on the one surface differs from that on the other only by a factor; but this factor simply disappears from equations (2)–(5) for the reason just assigned. We have therefore a general theorem, including, as a special case, the above statement relating to a sphere and a plane. Forming the combination $u + iv$ from u and v and calling this a *complex function of position on the surface*, this theorem may be stated as follows:

If one surface is conformally mapped upon another, every complex function of position which exists on the first is changed into a function of the same kind on the second.

It may perhaps be as well to obviate a misunderstanding

*This statement can also be easily verified without the use of formulæ; reference may be made to the works of C. Neumann and of Töpler, already cited.

which might arise at this point. To the same function $u + iv$ there corresponds a motion of the fluid on the one surface and on the other; it might be imagined that the one arose from the other by the transformation. This is of course true as regards the position of the equipotential curves and the stream-lines, but it is in no wise true of the velocity. Where the element of arc of one surface is greater than the element of arc of the other, there the velocity is correspondingly *smaller*. This is precisely the reason that the value $z = \infty$ loses its critical character on the sphere. At infinity on the plane, the velocity of the streaming, as we see at once, is infinitely small of the second order, and if infinity is a singular point, still the velocity there is less by two degrees than the velocity at a similar point in the finite part of the plane. Now let us refer to the formula given in the foot-note at the beginning of this section:

$$d\sigma = \frac{ds}{x^2 + y^2 + 1},$$

giving the element of arc of the sphere in terms of the element of arc of the plane. Here $x^2 + y^2 + 1$ is a quantity of precisely the second order and is cancelled in the transition to the sphere.

§ 6. *Connection between the foregoing Theory and the Functions of a complex Argument.*

Since we have now obtained the sphere as basis of operations, the theorems of §§ 3, 4 respecting rational functions and their integrals must be restated; we hereby gain in generality, the previously established theorems holding for infinitely

great values of z and being thus valid with no exceptions. This makes it the more interesting to trace the course of any particular rational function on the sphere and to consider means for its physical production.* But another important question

*A good example of not too elementary a character is the Icosahedron equation (cf. *Math. Ann.*, t. XII. pp. 502 *et seq.*),

$$w = \frac{-(z^{20} + 1) + 228(z^{15} - z^5) - 494z^{10})^3}{1728z^5(z^{10} + 11z^5 - 1)^5},$$

which is of the 60th degree in z . The infinities of w are coincident by fives at each of 12 points which form the vertices of an icosahedron inscribed in the sphere on which we represent the values of z . Corresponding to the 20 faces of this icosahedron, the sphere is divided into 20 equilateral spherical triangles. The middle points of these triangles are given by $w = 0$ and form cross-points of multiplicity two for the function w . Hence of the $2 \cdot 60 - 2 = 118$ cross-points, we already know (including the infinities) $4 \cdot 12 + 2 \cdot 20 = 88$.

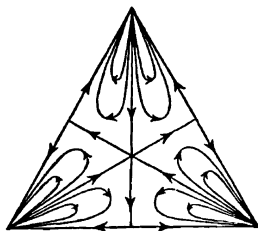

Fig. 13.

The remaining 30 are given by the middle points of the 30 sides of those 20 spherical triangles. The annexed figure is a diagram of one of these 20 triangles with the stream-lines drawn in; the remaining 19 are similar.

suggests itself during these investigations:—the different functions of position on the sphere are at the same time functions of the *argument* $x + iy$; whence this connection?

It must first be noticed that $x + iy$ is itself a complex function of *position* on the sphere, for the quantities x and y satisfy the differential equations already established in § 1 for u and v ; while working in the plane we may imagine that this function has an essential advantage over all other functions, but when the scene of operations is transferred to the sphere there is no longer any inducement to think so. In fact we are at once led to a generalisation of the remark which gave rise to this enquiry. If $u + iv$ and $u_1 + iv_1$ are both functions of $x + iy$, $u_1 + iv_1$ is also a function of $u + iv$; hence for plane and sphere we have the general theorem: *Of two complex functions of position, with the usual meaning of this expression in the theory of functions, each is a function of the other.*

But is this a peculiarity of these surfaces alone? It is certainly transferable to all such surfaces as can be conformally mapped upon part of a plane or of a sphere; this follows from the last theorem of the preceding section. But I maintain that *this peculiarity belongs to all surfaces*, whereby it is implicitly stated that a part of any *arbitrary* surface can be conformally mapped upon the plane or the sphere.

The proof follows at once, if we take x, y , the real and imaginary parts of a complex function of position on a surface, for curvilinear coordinates on that surface. For then the coefficients E, F, G , in the expression for the element of arc, must be such that equations (2)–(5) of the preceding section are

identically satisfied when x and y are substituted for p and q and also for u and v . *This, as we see at a glance, imposes the conditions $F = 0$, $E = G$.* But then the equations are transformed into the well-known ones,

$$\frac{\partial^2 u}{\partial x^2} + \frac{\partial^2 u}{\partial y^2} = 0, \quad \frac{\partial u}{\partial x} = \frac{\partial v}{\partial y}, \quad \frac{\partial u}{\partial y} = -\frac{\partial v}{\partial x}, \quad \text{etc.},$$

and these are the equations by which functions of the argument $x + iy$ are defined; hence $u + iv$ is a function of $x + iy$, as was to be shown.

At the same time the statement respecting conformal representation is confirmed. For, from the form of the expression for the element of arc,

$$ds^2 = E(dx^2 + dy^2),$$

it follows at once that the surface can be conformally mapped upon the xy plane by $x + iy$. This result may be expressed in a somewhat more general form, thus:

If two complex functions of position on two surfaces are known, and the surfaces are so mapped upon one another that corresponding points give rise to the same values of the functions, the surfaces are conformally mapped upon each other.

This is the converse of the theorem established at the end of the last section.

These theorems have all, as far as regards arbitrary surfaces, a definite meaning only when the attention is confined to small portions of the surface, within which the complex

functions of position have neither infinities nor cross-points. I have therefore spoken provisionally of *parts* of surfaces only. But it is natural to enquire concerning the behaviour of these relations when the *whole* of any closed surface is taken into consideration. This is a question which is intimately connected with the line of argument presently to be developed; §§ 19–21 are specially devoted to it.

§ 7. *Streamings on the Sphere resumed. Riemann's general Problem.*

A point has now been reached from which it is possible to start afresh and to take up the discussion contained in the first sections of this introduction in an entirely different manner; this leads us to a general and most important problem, in fact to Riemann's problem, the exact statement and solution of which form the real subject-matter of the present pamphlet.

The most important position in the previous presentation of the subject has been occupied by the function of $x + iy$; this has been interpreted by a steady streaming on the sphere, and characteristics of the function have been recognized in those of the streaming. Rational functions in particular, and their integrals have led to one simple class of streamings—*one-valued* streamings—in which *one* streaming only exists at every point of the sphere. Moreover, subject to the condition that no discontinuities other than those defined in § 2 may present themselves, these are *the most general* one-valued streamings possible on a sphere.

Now it seems possible, *ab initio*, to reverse the whole order of this discussion; *to study the streamings in the first place and thence to work out the theory of certain analytical functions*. The question as to the most general admissible streamings can be answered by physical considerations; the experimental constructions of § 4 and the principle of superposition giving us, in fact, means of defining each and every such streaming. The individual streamings define, to a constant of integration près, a complex function of position whose variations can be thereby followed throughout their whole range. Every such function is an analytical function of every other. From the connection between any two complex functions of position forms of analytical dependence are found, considered initially as to their characteristics and only afterwards identified—to complete the connection—with the usual form of analytical dependence.

This is all too clear to need a more minute explanation; let us proceed at once to the proposed generalisation. And even this, after the previous discussion, is almost self-evident. All the problems just stated for the sphere may be stated in exactly the same terms if instead of the sphere *any arbitrary closed surface is given*. On this surface one-valued streamings and hence complex functions of position can be defined and their properties grasped by means of concrete demonstrations. The simultaneous consideration of various functions of position thus changes the results obtained into so many theorems of ordinary analysis. The fulfilment of this design constitutes *Riemann's Theory*; the chief divisions into which the following exposition falls have been mentioned incidentally.

PART II.

RIEMANN'S THEORY.

§ 8. *Classification of closed Surfaces according to the Value of the Integer p .**

All closed surfaces which can be conformally represented upon each other by means of a uniform correspondence, are, of course, to be regarded as equivalent for our purposes. For every complex function of position on the one surface will be changed by this representation into a similar function on the other surface; hence, the analytical relation which is graphically expressed by the co-existence of two complex functions on the one surface is entirely unaffected by the transition to the other surface. For instance, the ellipsoid may be conformally represented, by virtue of known investigations, on a sphere, in such a way that each point of the former corresponds to one and only one point of the latter; this shows us that the ellipsoid is as suitable for the representation of rational functions and their integrals as the sphere.

It is of still greater importance to find an element which is unchanged, not only by a conformal transformation, but by

*The presentation of the subject in this section differs occasionally from Riemann's, since surfaces with boundaries are not at first taken into account, and thus, instead of **cross-cuts** from one point on the **boundary** to another, so-called **loop-cuts** are used (cf. C. Neumann, *Vorlesungen über Riemann's Theorie der Abel'schen Integrale*, pp. 291 *et seq.*).

any uniform transformation of the surface.* Such an element is Riemann's p , the number of loop-cuts which can be drawn on a surface without resolving it into distinct pieces. The simplest examples will suffice to impress this idea on our minds. For the sphere, $p = 0$, since it is divided into two disconnected regions by any closed curve drawn on its surface. For the ordinary anchor-ring, $p = 1$; a cut can be made along one, and only one, closed curve—though this may have a very arbitrary form—without resolving the surface into distinct portions.

That it is impossible to represent surfaces having different p 's upon one another, the correspondence being uniform, seems evident.†

It is more difficult to prove the converse, that *the equality of the p 's is a sufficient condition for the possibility of a uniform correspondence between the two surfaces.* For proof of this

*Deformations by means of *continuous* functions only are considered here. Moreover in the arbitrary surfaces of the text certain particular occurrences are for the present excluded. It is best to imagine them without singular points; branch-points and hence the penetration of one sheet by another will be considered later on (§ 13). The surfaces must not be *unifacial*, *i.e.* it must not be possible to pass continuously on the surface from one side to the other (cf. however § 23). It is also assumed—as is usual when a surface is *completely* given—that it can be separated into simply-connected portions by a *finite* number of cuts.

†It is not meant, however, that this kind of geometrical certainty needs no further investigation; cf. the explanations of G. Cantor (*Crelle*, t. LXXXIV. pp. 242 *et seq.*). But these investigations are meanwhile excluded from consideration in the text, since the principle there insisted upon is to base all reasoning ultimately on intuitive relations.

important proposition I must here confine myself to references in a foot-note.* In consequence of this, when investigating closed surfaces, we are justified, so long as purely descriptive general relations are involved, in adopting the simplest possible type of surface for each p . We shall speak of these as *normal surfaces*. For the determination of quantitative properties the normal surfaces are of course insufficient, but even here they provide a means of orientation.

Let the normal surface for $p = 0$ be the sphere, for $p = 1$, the anchor-ring. For greater values of p we may imagine a sphere with p appendages (handles) as in the following figure for $p = 3$.

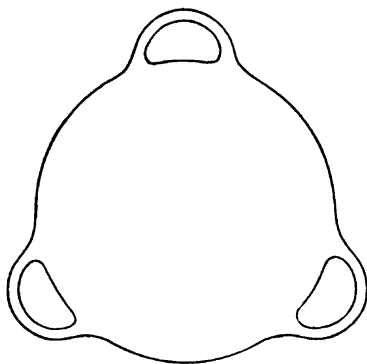

Fig. 14.

There is, of course, a similar normal surface for $p = 1$;

*See C. Jordan: "Sur la déformation des surfaces," *Liouville's Journal*, ser. 2, t. XI. (1866). A few points, which seemed to me to call for elucidation, are discussed in *Math. Ann.*, t. VII. p. 549, and t. IX. p. 476.

the surfaces being, by hypothesis, not rigid, but capable of undergoing arbitrary distortions.

On these normal surfaces there must now be assigned certain *cross-cuts* which will be needed in the sequel. For the case $p = 0$ these do not present themselves. For $p = 1$, *i.e.* on the anchor-ring, they may be taken as a meridian A combined with a curve of latitude B .

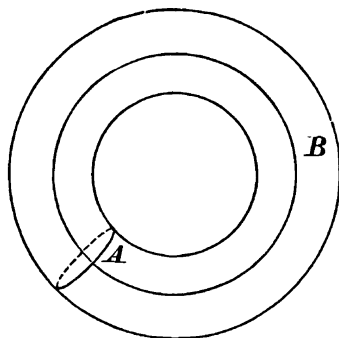

Fig. 15.

In general $2p$ cross-cuts will be needed. It will, I think, be intelligible, with reference to the following figure, to speak of a meridian and a curve of latitude in connection with each handle of a normal surface.

We choose the $2p$ cross-cuts such that there is a meridian and a curve of latitude to each handle. These cross-cuts will be denoted in order by A_1, A_2, \dots, A_p , and B_1, B_2, \dots, B_p .

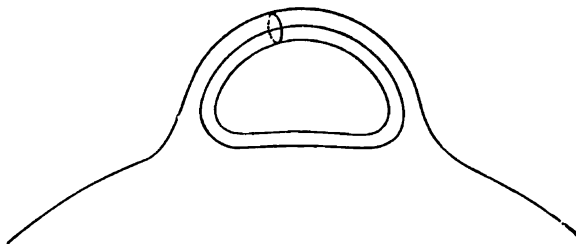

Fig. 16.

§ 9. *Preliminary Determination of steady Streamings on arbitrary Surfaces.*

We have now before us the task of defining on arbitrary (closed) surfaces, the most general, one-valued, steady streamings, having velocity-potentials, and subject to the condition that no infinities are admitted other than those named in § 2.* For this purpose we turn to the normal surfaces of the last section and once more employ the experimental methods of the theory of electricity. We imagine the given surface to be

*These infinities were first defined for the plane (or the sphere) only. But it is clear how to make the definition apply to arbitrary curved surfaces; the generalisation must be made in such a manner that the original infinities are restored when the surface and the steady streamings on it are mapped by a conformal representation upon the plane. This limitation in the nature of the infinities implies that only a *finite* number of them is possible in the streamings in question, but it must suffice to state this as a fact here. Similarly, as I may point out in passing, it follows from our premises that only a finite number of cross-points can present themselves in the course of these streamings.

covered with an infinitely thin homogeneous film of a conducting material, and we then employ those appliances whose use we learnt in § 4. Thus we may place the two poles of a galvanic battery at any two points of the surface; a streaming is then produced having these two points as sources of equal and opposite strength. Next we may join any two points on the surface by one or more adjacent but non-intersecting curves and make these seats of constant electromotive force, bearing in mind throughout the remarks made in § 4 about the necessary experimental processes for this case. A steady motion is then obtained, in which the two points are vortex-points of equal and opposite intensity. Further, we superpose various forms of motion and finally, when necessary, allow separate infinities to coalesce in the limit in order to produce infinities of higher order. Everything proceeds exactly as on the sphere and we have the following proposition in any case:

If the infinities are limited to those discussed in § 2, and if moreover the condition that the sum of all the logarithmic residues must vanish is satisfied, then there exist on the surface complex functions of position which become infinite at arbitrarily assigned points and moreover in an arbitrarily specified manner and are continuous elsewhere over the whole surface.

But for $p > 0$ the possibilities are by no means exhausted by these functions. For there can now be found an experimental construction which was impossible on the sphere. There are closed curves on these surfaces along which they may be cut without being resolved into distinct pieces. There is nothing to prevent the electricity flowing on the surface from one side

of such a curve to the other. *We have then as much justification for considering one or more of these consecutive curves as seats of constant electromotive force as we had in the case of the curves of § 4 which were drawn from one end to the other.*

The streamings so obtained have no discontinuities; they may be denoted as *streamings which are finite everywhere* and the associated complex functions of position as *functions finite everywhere*. These functions are necessarily infinitely **multiform**, for they acquire a real modulus of periodicity, proportional to the assumed electromotive force, as often as the given curve is crossed in the same direction.*

We next enquire how many independent streamings there may be, so defined as finite everywhere. Obviously any two curves on the surface, seats of equal electromotive forces, are equivalent for our purpose when by continuous deformation on the surface one can be brought to coincidence with the other. If after the process of deformation parts of the curve are traversed twice in opposite directions, these may be simply neglected. Consequently it is shown that *every closed curve is equivalent to an integral combination of the cross-cuts A_i , B_i defined as in the previous section.*

For let us trace the course of any closed curve on a normal

*But this is not to imply that any disposition has herewith been made of the periodicity of the imaginary part of the function. For if u is given, v is completely determined, to an additive constant près, by the differential equations (1) of p. 1, and hence the moduli of periodicity which v may possess at the cross-cuts A_i , B_i cannot be arbitrarily assigned.

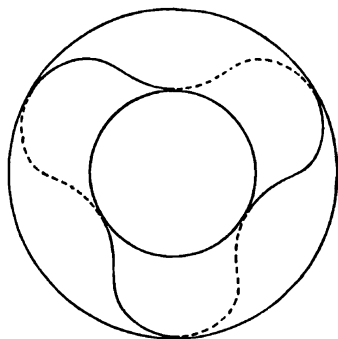

Fig. 17.

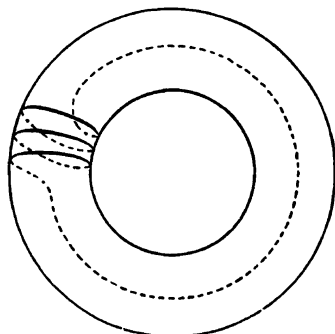

Fig. 18.

surface;* for $p = 1$ the correctness of the statement follows immediately; we need but consider an example as given in the above figures. The curve drawn on the anchor-ring in Fig. 17 can be brought to coincidence with that in Fig. 18 by deformation alone; it is thus equivalent to a triple description of the meridian A (cf. Fig. 15) and a single description of the curve of latitude B .

Further, let $p > 1$. Then whenever a curve passes through one of the handles a portion can be cut off, consisting of deformations of an integral combination of the meridians and corresponding curves of latitude belonging to the handle in question. When all such portions have been removed there remains a closed curve, which can either be reduced at once to

*For another proof see C. Jordan, "Des contours tracés sur les surfaces," *Liouville's Journal*, ser. 2, t. XI. (1866).

a single point on the surface—and then has certainly no effect on the electric streaming—or it may completely surround one or more of the handles as in Fig. 19. Fig. 20 shows how such a curve can be altered by deformation; by continuation of the process here indicated, it is changed into a curve consisting

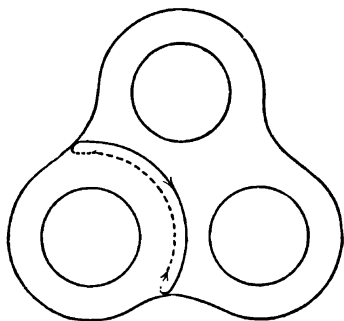

Fig. 19.

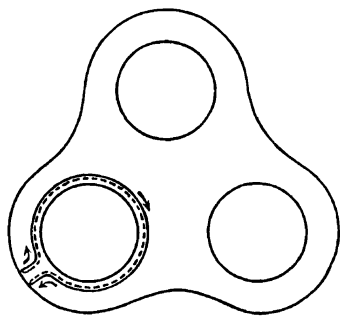

Fig. 20.

of the inner rim of the handle and one of its meridians, but every portion is traversed twice in opposite directions. Thus this curve also contributes nothing to the streaming. This conclusion might indeed have been reached before, from the fact that this curve, herein resembling a curve which reduces to a point, resolves the surface into distinct portions.

Nothing *more* is therefore to be gained by the consideration of arbitrary closed curves than by suitable use of the $2p$ curves A_i, B_i . The most general streaming we can produce which is finite everywhere is obtained by making the $2p$ cross-cuts seats of a constant electromotive force. Or, otherwise expressed:

The most general function we have to construct, which is finite everywhere, is the one whose real part has, at the $2p$ cross-cuts, arbitrarily assigned moduli of periodicity.

§ 10. *The most general steady Streaming. Proof of the Impossibility of other Streamings.*

If we combine additively the different complex functions of position constructed in the preceding section, we obtain a function whose arbitrary character we can take in at a glance. Without explicitly restating the conditions which we assumed once and for all respecting the infinities, we may say that *this function becomes infinite in arbitrarily specified ways at arbitrarily assigned points, the real part having moreover arbitrarily assigned moduli of periodicity at the $2p$ cross-cuts.*

I now say, that *this is the most general function to which a one-valued streaming on the surface corresponds.* For proof we may reduce this statement to a simpler one. If any complex function of this kind is given on the surface, we have, by what precedes, the means of constructing another function, which becomes infinite in the same manner at the same points and whose real part has at the cross-cuts A_i , B_i the same moduli of periodicity as the real part of the given function. The difference of these two functions is a new function, nowhere infinite, whose real part has vanishing moduli of periodicity at the cross-cuts—this function, of course, again defines a one-valued streaming. *It is obvious we must prove that such a function does not exist, or rather, that it reduces to a constant*

The proof is not difficult. As regards the strict demonstration, I confine myself to the remark that it depends on the most general statement of Green's Theorem;* the following is intended to make the impossibility of the existence of such a function immediately obvious. Even if, on account of its indefinite form, the argument may possibly not be regarded as a rigorous proof,[†] it would still seem profitable to examine, by this method as well, the principles on which that theorem is based.

Firstly, then, in the particular case $p = 0$, let us enquire why a one-valued streaming, finite everywhere, cannot exist on the sphere. This is most easily shown by tracing the stream-lines. Since no infinities are to arise, a stream-line cannot have an abrupt termination, as would be the case at a source or at an algebraic discontinuity. Moreover it must be remembered that the flow along adjacent stream-lines is necessarily in the same direction. It is thus seen that only two kinds of non-terminating stream-lines are possible; either the curve winds closer and closer round an asymptotic point—but this gives rise to an infinity—or the curve is closed. But if *one* stream-line is closed, so is the next. They thus surround a smaller and smaller part of the surface of the sphere; consequently we are unavoidably led to a vortex-point, *i.e.* once more to an infinity, and a streaming finite everywhere is an impossibility. It is

*For this proposition see Beltrami, *l.c.*, p. 354.

[†]I may remind the reader that Green's theorem itself may be proved intuitively; cf. Tait, "On Green's and other allied Theorems," *Edin. Trans.* 1869–70, pp. 69 *et seq.*

true that we have here not taken into account the possibilities involved when cross-points present themselves. But since these points are always finite in number, as was pointed out above, there can be but a finite number of stream-lines through them. Let the sphere be divided by these curves into regions, and in each individual region apply the foregoing argument, then the same result will be obtained.

Next, if $p > 0$, let us again make use of the normal surfaces of § 8. By what we have just said, the existence on these surfaces of one-valued streamings which are finite everywhere, is due to the presence of the handles. A stream-line cannot be represented on a normal surface, any more than on a sphere, by a closed curve which can be reduced to a point. But further, a curve of the form shown in Fig. 19 is not admissible. For with this curve there would be associated others of the form shown in Fig. 20, so that ultimately a curve would be obtained with its parts described twice in opposite directions. A stream-line must therefore necessarily *wind round* one or other of the handles, that is, it may simply pass once through a handle or it may wind round it several times along the meridians and curves of latitude. In all cases then a portion of a stream-line can be separated from the remainder, equivalent in the sense of the last section to an integral combination of the appropriate meridians and curves of latitude. Now the value of u , the real part of the complex function defined by the streaming, increases constantly along a stream-line. Further, the description of two curves, equivalent in the sense of the last section, necessarily produces the same increment in u . There exists

then a combination of at least one meridian and one curve of latitude the description of which yields a non-vanishing increment of u . This is also necessarily true for the meridian or the curve of latitude alone. But the increment which u receives by the *description* of the meridian corresponds to the *crossing* of the curve of latitude and *vice versa*. Hence at one meridian or curve of latitude, at least, u has a non-vanishing modulus of periodicity, and a one-valued streaming, finite everywhere, having all its moduli of periodicity equal to zero, is impossible. Q.E.D.

§ 11. *Illustration of the Streamings by means of Examples.*

It would appear advisable to gain, by means of examples, a clear view of the general course of the streamings thus defined, in order that our propositions may not be mere abstract statements, but may be connected with concrete illustrations.* This is comparatively easy in the given cases so long as we confine ourselves to qualitative relations; exact quantitative determinations would of course require entirely different appliances. For simplicity I confine myself to surfaces with a plane of symmetry coinciding with the plane of the drawing, and on these I consider only those streamings for which the apparent boundary of the surface (*i.e.* the curve of section of the surface by the plane of the paper) is either a stream-line or an equipotential curve. There is a considerable advantage

*Such a means of orientation, it may be presumed, in also of considerable value for the practical physicist.

in this, for the stream-lines need only be drawn for the upper side of the surface, since on the under side they are identically

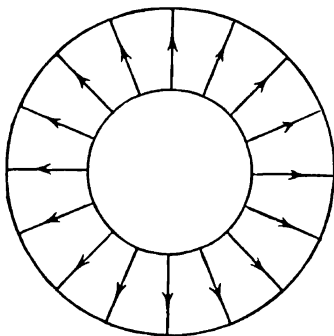

Fig. 21.

repeated.*

Let us begin with streamings, finite everywhere, on the anchor-ring $p = 1$; let a curve of latitude (or several such curves) be the seat of electromotive force. Then Fig. 21 is obtained in which all the stream-lines are meridians and no cross-points present themselves; the meridians are there shown as portions of radii; the arrows give the direction of the streaming on the upper side, on the lower side the direction is exactly reversed.

*Drawings similar to these were given in my memoir "Ueber den Verlauf der Abel'schen Integrale bei den Curven vierten Grades," *Math. Ann.* t. X., though indeed a somewhat different meaning is attached there to the Riemann's surfaces, so that in connection with them the term fluid-motion can only be used in a transferred sense; cf. the remarks in § 18.

In the conjugate streaming, the curves of latitude play the part of the meridians in the first example; this is shown in the following drawing:

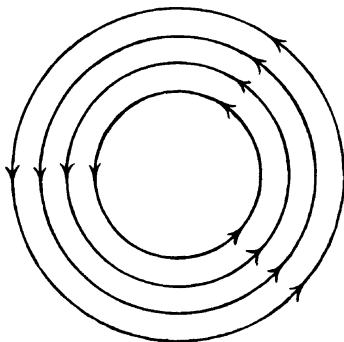

Fig. 22.

The direction of motion in this case is the same on the upper and lower sides.

Let us now deform the anchor-ring, $p = 1$, by causing two excrescences to the right of the figure, roughly speaking, to grow from it, which gradually bend towards each other and finally coalesce. *We then have a surface $p = 2$ and on it a pair of conjugate streamings as illustrated by Figures 23 and 24.*

Here, as we may see, two *cross-points* have presented themselves on the right (of which of course only one is on the upper side and therefore visible). An analogous result is obtained when we study streamings which are finite everywhere on a surface for which $p > 1$. In place of further explanations I give

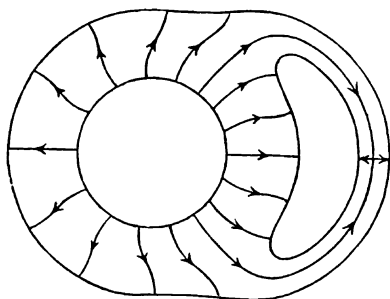

Fig. 23.

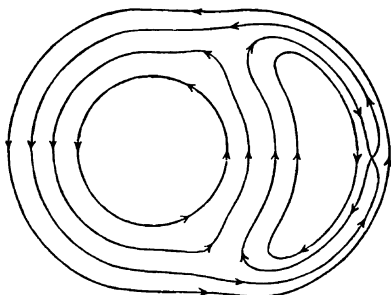

Fig. 24.

two more figures with four cross-points in each, relating to the case $p = 3$.

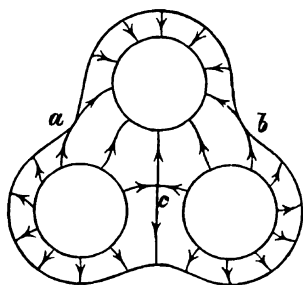

Fig. 25.

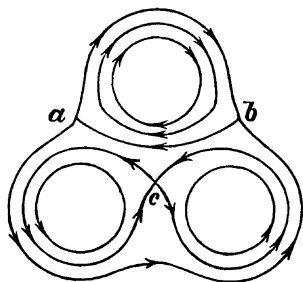

Fig. 26.

These arise, if on all “handles” of the surface the curves of latitude or the meridians respectively are seats of electromotive force. On the two lower handles the directions are the same, and opposed to that on the upper handle. Of the cross-

points, two are at a and b , the third at c , and the fourth at the corresponding point on the under side. It is difficult to see the cross-points at a and b (Fig. 25) merely because foreshortening due to perspective takes place at the boundary of the figure, and hence both stream-lines which meet at the cross-point appear to touch the edge. If the streamings on the under side of the surface (along which the flow is in the opposite direction) are taken into account, any obscurity of the figure at this point will disappear.

Let us now return to the anchor-ring, $p = 1$, and let two logarithmic discontinuities be given on it. The appropriate figures are obtained if Figs. 23, 24 are subjected to a process of deformation, which may also be applied, with interesting as well as profitable results, to more general cases. We draw together the parts to the left of each figure and stretch out the parts to the right, so that we obtain, in the first place, the following figures:

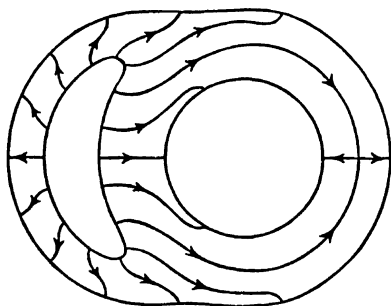

Fig. 27.

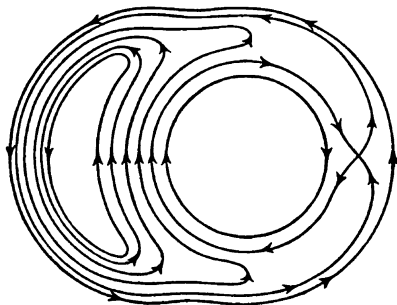

Fig. 28.

and then we reduce the handle on the left, which has already become very narrow, until it is merely a curve, when we reject it altogether. Hence, from the streaming, finite everywhere, on the surface $p = 2$, we have obtained on the surface $p = 1$ a streaming with two logarithmic discontinuities. The figures are now of this form,

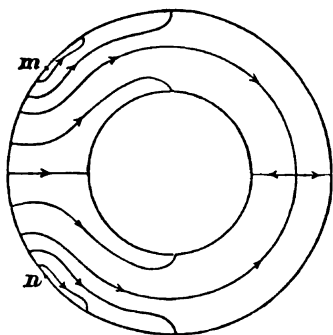

Fig. 29.

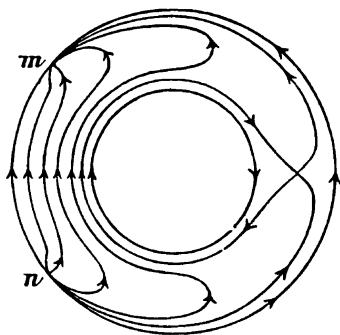

Fig. 30.

The two cross-points of Figs. 23, 24 remain, m and n are the two logarithmic discontinuities; and these moreover, in Fig. 29, are vortex-points of equal and opposite intensity, and, in Fig. 30, sources of equal and opposite strength. Here, again, it results from our method of projection that in the second case all the stream-lines except one seem to touch the boundary at m and n .

If we finally allow m and n to coalesce, giving rise to a simple algebraic discontinuity, we obtain the following figures, in which, as may be perceived, the cross-points retain their

original positions.

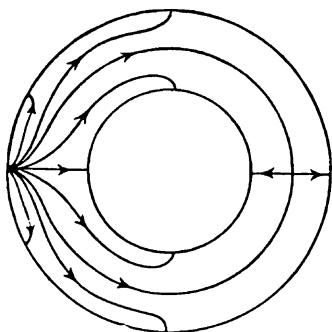

Fig. 31.

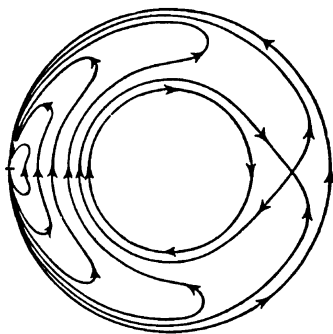

Fig. 32.

There is no occasion to multiply these figures, as it is easy to construct other examples on the same models. But one more point must be mentioned. The number of cross-points obviously increases with the p of the surface and with the number of infinities; algebraic infinities of multiplicity r may be counted as $r + 1$ logarithmic infinities; then, on the sphere, with μ logarithmic infinities, the number of proper cross-points is, in general, $\mu - 2$. Moreover unit increase in p is accompanied, in accordance with our examples, by an increase of two in the number of cross-points. Hence it may be surmised that the number of cross-points is, in every case, $\mu + 2p - 2$. A strict proof of this theorem, based on the preceding methods, would present no especial difficulty;* but it would lead us too

*It would seem above all necessary for such a proof to be perfectly

far afield. The only particular case of the theorem of which use will be subsequently made, is known to hold by the usual proofs of analysis situs; it deals (§ 14) with streamings presenting m simple algebraic discontinuities, giving rise therefore to $2m + 2p - 2$ cross-points.

§ 12. *On the Composition of the most general Function of Position from single Summands.*

The results of § 10 enable us to obtain a more concrete illustration of the most general complex function of position existing on a surface by adding together single summands of the simplest types.

Let us first consider functions *finite everywhere*. Let u_1, u_2, \dots, u_μ be potentials, finite everywhere. These may be called *linearly dependent* if they satisfy a relation

$$a_1 u_1 + a_2 u_2 + \dots + a_\mu u_\mu = A$$

with constant coefficients. Such a relation leads to corresponding equations for the $2p$ series of μ moduli of periodicity possessed by u_1, u_2, \dots, u_μ at the $2p$ cross-cuts of the surface. Conversely, by the theorem of § 10, such equations for the moduli of periodicity would of themselves give rise to a linear relation in the u 's. It then follows that $2p$ *linearly independent potentials finite everywhere*, u_1, u_2, \dots, u_{2p} , can be found in

clear about the various possibilities connected with the deformation of a given surface into the normal surface, cf. § 8.

an indefinite number of ways, but from these every other potential, finite everywhere, can be linearly constructed:

$$u = a_1u_1 + \dots + a_{2p}u_{2p} + A.$$

For u_1, u_2, \dots, u_{2p} can *e.g.* be so chosen that each has a non-vanishing modulus of periodicity at one only of the $2p$ cross-cuts (where, of course, to each cross-cut, one, and only one, potential is assigned). And in $\sum a_i u_i$ the constants a_i can be so chosen that this expression has at each cross-cut the same modulus of periodicity as u . Then $u - \sum a_i u_i$ is a constant and we have the formula just given.

Passing now from the potentials u to the functions $u + iv$, finite everywhere, suppose, for simplicity, that coordinates x, y , employed on the surface (§ 6), are such that u and v are connected by the equations

$$\frac{\partial u}{\partial x} = \frac{\partial v}{\partial y}, \quad \frac{\partial u}{\partial y} = -\frac{\partial v}{\partial x}.$$

Now let u_1 be an arbitrary potential, finite everywhere. Construct the corresponding v_1 ; then u_1 and v_1 are *linearly independent*. For if between u_1 and v_1 there were an equation

$$a_1u_1 + b_1v_1 = \text{const.}$$

with constant coefficients, this would entail the following equations:

$$a_1 \frac{\partial u_1}{\partial x} + b_1 \frac{\partial v_1}{\partial x} = 0, \quad a_1 \frac{\partial u_1}{\partial y} + b_1 \frac{\partial v_1}{\partial y} = 0,$$

whence, by means of the given relations, the following contradictory result would be obtained:

$$\frac{\partial u_1}{\partial x} = 0, \quad \frac{\partial u_1}{\partial y} = 0.$$

Further, let u_2 be linearly independent of u_1, v_1 . Then we may take the corresponding v_2 and obtain the more general theorem: *The four functions u_1, u_2, v_1, v_2 , are likewise linearly independent.* For from any linear relation

$$a_1 u_1 + a_2 u_2 + b_1 v_1 + b_2 v_2 = \text{const.},$$

by means of the relations among the u 's and the v 's, we should obtain the following equations:

$$(a_1 a_2 + b_1 b_2) \frac{\partial u_1}{\partial x} - (a_1 b_2 - a_2 b_1) \frac{\partial v_1}{\partial x} + (a_2^2 + b_2^2) \frac{\partial u_2}{\partial x} = 0,$$

$$(a_1 a_2 + b_1 b_2) \frac{\partial u_1}{\partial y} - (a_1 b_2 - a_2 b_1) \frac{\partial v_1}{\partial y} + (a_2^2 + b_2^2) \frac{\partial u_2}{\partial y} = 0,$$

from which by integration a linear relation among u_1, v_1, u_2 would follow.

Proceeding thus we obtain finally $2p$ linearly independent potentials,

$$u_1, v_1, \quad u_2, v_2, \quad \dots\dots\dots, \quad u_p, v_p,$$

where each v is associated with the u having the same suffix. Writing $u_\alpha + i v_\alpha = w_\alpha$ and calling the functions w_1, w_2, \dots, w_μ , which are finite everywhere, linearly independent if no relation

$$c_1 w_1 + c_2 w_2 + \dots\dots\dots + c_\mu w_\mu = C$$

exists among them, where c_1, \dots, c_μ, C are arbitrary *complex* constants, we have at once: *The p functions w_1, \dots, w_p , finite everywhere, are linearly independent.* For if there were a linear relation we could separate the real and imaginary parts and thus obtain linear relations among the u 's and v 's.

But, further, it follows *that every arbitrary function, finite everywhere, can be made up from w_1, w_2, \dots, w_p in the following form:*

$$w = c_1 w_1 + c_2 w_2 + \dots + c_p w_p + C.$$

For by proper choice of the complex constants c_1, c_2, \dots, c_p , since $u_1, \dots, u_p, v_1, \dots, v_p$ are linearly independent, we can assign to the real part of the function w defined by this formula, arbitrary moduli of periodicity at the $2p$ cross-cuts.

This is the theorem we were to prove in the present section, in so far as it relates to the construction of functions finite everywhere. The transition to *functions with infinities* is now easily effected.

Let $\xi_1, \xi_2, \dots, \xi_\mu$ be the points at which the function is to become infinite in any specified manner. Introduce an auxiliary point η and construct a series of single functions

$$F_1, F_2, \dots, F_\mu,$$

each of which becomes infinite, and that in the specified manner, at one only of the points ξ , and in addition has, at η , a logarithmic discontinuity whose residue is equal and opposite to the logarithmic residue of the ξ in question. The sum

$$F_1 + F_2 + \dots + F_\mu$$

is then continuous at η , for the sum of all the residues of the discontinuities ξ is known to be zero. Moreover, this sum only becomes infinite at the ξ 's, and there in the specified manner. It therefore differs from the required function only by a function which is finite everywhere. *The required function may thus be written in the form*

$$F_1 + F_2 + \dots + F_\mu + c_1 w_1 + c_2 w_2 + \dots + c_p w_p + C,$$

whereby the theorem in question has been established for the general case.

This result obviously corresponds to the dismemberment of complex functions on a sphere considered in § 4, and there deduced in the usual way from the reduction of rational functions to partial fractions.

§ 13. *On the Multiformity of the Functions. Special Treatment of uniform Functions.*

The functions $u + iv$, under investigation on the surfaces in question, are in general infinitely multiform, for on the one hand a modulus of periodicity is associated with every logarithmic infinity, and on the other hand we have the moduli of periodicity at the $2p$ cross-cuts A_i, B_i , whose real parts may be arbitrarily chosen. I assert that *in no other manner can $u + iv$ become multiform*. To prove this we must go back to the conception of the equivalence of two curves on a given surface which was brought forward in § 9, primarily for other purposes. Since the differential coefficients of u and v (or,

what is the same thing, the components of the velocity of the corresponding streaming) are one-valued at every point of the surface, two equivalent closed curves not separated by a logarithmic discontinuity yield the same increment in u , and also in v . But we found that every closed curve was equivalent to an integral combination of the cross-cuts A_i, B_i . We further remarked (§ 10) that the description of A_i produced the same modulus of periodicity as the crossing of B_i it and *vice versa*. And from this the above theorem follows by known methods.

It will now be of special interest to consider *uniform* functions of position; from the foregoing all such functions can be obtained by admitting only purely *algebraical* infinities and by causing all the $2p$ moduli of periodicity at the cross-cuts A_i, B_i to vanish. To simplify the discussion, *simple* algebraic discontinuities alone need be considered. For we know from § 3 that the ν -fold algebraic discontinuity can be derived from the coalescence of ν simple ones, in which case, it should be borne in mind, cross-points are absorbed whose total multiplicity is $\nu - 1$. Let m points then be given as the simple algebraic infinities of the required function. We first construct any m functions of position Z_1, \dots, Z_m each of which has a simple algebraic infinity at one only of the given points but is otherwise arbitrarily multiform. From these Z 's the most general complex function of position with simple algebraic infinities at the given points can be compounded by the last section in the form

$$a_1 Z_1 + a_2 Z_2 + \dots + a_m Z_m + c_1 w_1 + c_2 w_2 + \dots + c_p w_p + C,$$

where a_1, \dots, a_m are arbitrary constant coefficients. To make this function *uniform* the modulus of periodicity for each of the $2p$ cross-cuts must be equated to zero; but these moduli of periodicity are linearly compounded, by means of the a 's and c 's, of the moduli of periodicity of the z 's and w 's; *there are thus $2p$ linear homogeneous equations for the $m + p$ constants a and c .* Assume that these equations are linearly independent,* this important proposition follows:

Subject to this condition, uniform functions of position with m arbitrarily assigned simple algebraic discontinuities exist only if $m \geq p + 1$; and these functions contain $m - p + 1$ arbitrary constants which enter linearly.

Now let the m infinities be moveable, then m new degrees of freedom are introduced. Moreover it is clear that m arbitrary points on the surface can be changed by continuous displacement into m others equally arbitrary. It may therefore be stated—bearing in mind, however, under what conditions—that *the totality of uniform functions with m simple algebraic*

*If they are not so, the consequence will be that the number of uniform functions which are infinite at the m given points will be *greater* than that given in the text. The investigations of this possibility, especially Roch's (*Crelle*, t. LXIV.), are well known; cf. also for the algebraical formulation, Brill and Nöther: "Ueber die algebraischen Functionen und ihre Verwendung in der Geometrie," *Math. Ann.* t. VII. I cannot pursue these investigations in the text, although they are easily connected with Abel's Theorem as given by Riemann in No. 14 of the Abelian Functions, and will merely point out with reference to later developments in the text (cf. § 19) that *the $2p$ equations are certainly not linearly independent if m surpasses the limit $2p - 2$.*

discontinuities existing on a given surface forms a continuum of $2m - p + 1$ dimensions.

Having now proved the existence and ascertained the degrees of freedom of the uniform functions, we will, as simply and directly as possible, enunciate and prove another important property that they possess. The number of their infinities m is of far greater import than has yet appeared, for I now state that *the function $u + iv$ assumes any arbitrarily assigned value $u_0 + iv_0$ at precisely m points.*

To prove this, follow the course of the curves $u = u_0, v = v_0$ on the surface. It is clear from § 2 that each of these curves passes once through every one of the m infinities. On the other hand it follows by the reasoning of § 10 that every circuit of each of these curves must have at least one infinity on it. Hence the statement is at once proved for very great values of u_0, v_0 ; for it was shewn in § 2 that the corresponding curves $u = u_0, v = v_0$ assume in the vicinity of each infinity the form of small circles through these points, which necessarily intersect in *one* point other than the discontinuity (which last is hereafter to be left out of account).

But from this the theorem follows universally, *since, by continuous variation of u_0, v_0 , an intersection of the curves $u = u_0, v = v_0$ can never be lost*; for, from the foregoing, this could only occur if several points of intersection were to coalesce, separating afterwards in diminished numbers. Now the systems of curves u, v are orthogonal; real points of intersection can then only coalesce at cross-points (at which points coalescence does actually take place); but these cross-points

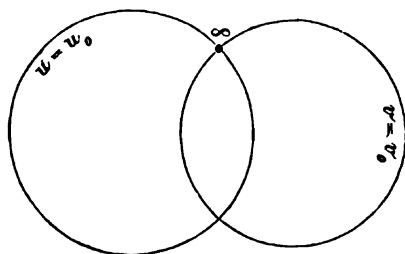

Fig. 33.

are finite in number and therefore cannot divide the surface into different regions. Thus the possibility of a coalescence need not be considered and the statement is proved.

It is valuable in what follows to have a clear conception of the distribution of the values of $u + iv$ near a cross-point. A careful study of Fig. 1 will suffice for this purpose. For instance, it will be observed that of the m moveable points of intersection of the curves $u = u_0$, $v = v_0$, $\nu + 1$ coalesce at the ν -fold cross-point.

Considerations similar to those here applied to uniform functions apply also to multiform functions; I do not enlarge on them, simply because the limitations of the subject-matter render them unnecessary; moreover it is only in the very simplest case that a comprehensible result can be obtained. Suffice it to refer in passing to the fact that a complex function with more than two incommensurable moduli of periodicity can be made to approach infinitely near every arbitrary value at every point.

§ 14. *The ordinary Riemann's Surfaces over the $x + iy$ Plane.*

Instead of considering the distribution of the values of the function $u + iv$ over the original surface, the process may, so to speak, be reversed. We may represent the values of the function—which for this reason is now denoted by $x + iy$ —in the usual way on the plane (or on the sphere)* and we may study the *conformal representation* of the original surface which (by § 5) is thus obtained. For simplicity, we again confine our attention to uniform functions, although the consideration of conformal representation by means of multiform functions is of particular interest.†

A moment's thought shows that we *are thus led to the very surface, many-sheeted, connected by branch-points, extending over the xy plane, which is commonly known as a Riemann's surface.*

For let m be the number of simple infinities of $x + iy$ on the original surface; then $x + iy$, as we have seen, takes *every* value m times on the given surface. *Hence the conformal representation of the original surface on the $x + iy$ plane covers that plane, in general, with m sheets.* The only exceptional positions are taken by those values of $x + iy$ for which some of the

*I speak throughout the following discussion of the plane rather than of the sphere in order to adhere as far as possible to the usual point of view.

†Cf. Riemann's remarks on representation by means of functions which are finite everywhere, in No. 12 of his Abelian Functions.

m associated points on the original surface coalesce, positions therefore which correspond to *cross-points*. To be perfectly clear let us once more make use of Fig. 1. It follows from this figure that the vicinity of a ν -fold cross-point can be divided into $\nu + 1$ sectors in such a way that $x + iy$ assumes the same system of values in each sector. Hence, above the corresponding point of the $x + iy$ plane, $\nu + 1$ sheets of the conformal representation are connected in such a way that in describing a circuit round the point the variable passes from one sheet to the next, from this to a third and so on, a $(\nu + 1)$ -fold circuit being required to bring it back to the starting-point. But this is exactly what is usually called a *branch-point*.* The representation at this point is of course not conformal; it is easily shown that the angle between any two curves which meet at the cross-point on the original surface is multiplied by precisely $\nu + 1$ on the Riemann's surface over the $x + iy$ plane.

But at the same time we recognize the importance of this many-sheeted surface for the present purpose. All surfaces which can be derived from one another by a conformal representation with a uniform correspondence of points are equivalent for our purposes (§ 8). We may therefore adopt the m -sheeted surface over the plane as the basis of our operations

*In § 11 the number of cross-points of $x + iy$ was stated without proof to be $2m + 2p - 2$. We now see that this statement was a simple inversion of the known relation among the number of branch-points (or rather their total multiplicity), the number of sheets m , and the p of a many-sheeted surface (where p is the maximum number of loop-cuts which can be drawn on this many-sheeted surface without resolving it into distinct portions).

instead of the surface hitherto employed, which was supposed without singularities, anywhere in space. And the difficulty which might be feared owing to the introduction of branch-points is avoided from the first; for we consider on the m -sheeted surface only those streamings whose behaviour near a branch-point is such that when they are traced on the original surface by a reversal of the process, the only singularities produced are those included in the foregoing discussion. To this end it is not even necessary to know of a corresponding surface in space; for we are only concerned with ratios in the immediate vicinity of the branch-points, *i.e.* with differential relations to be satisfied by the streamings.* And there is no longer any reason, in speaking of arbitrarily curved surfaces, for postulating them as free from singularities; *they may even consist of several sheets connected by branch-points and along branch-lines*. But whichever of the unlimited number of equivalent surfaces may be selected as basis, we must distinguish between *essential* properties common to all equivalent surfaces, and *non-essential* associated with particular individuals. To the former belongs the integer p ; and the “moduli,” which are discussed more fully in § 18, also belong to them;—to the latter belong the kind and position of the branch-points of many-sheeted surfaces. If we take an ideal surface possessing only the essential properties, then the branch-points of a

*For the explicit statement of these relations cf. the usual text-books, also in particular C. Neumann: *Das Dirichlet'sche Princip in seiner Anwendung auf die Riemann'schen Flächen*. Leipzig, 1865.

many-sheeted surface correspond on this simply to ordinary points which, generally speaking, are not distinguished from the other points and which are only noticeable from the fact that, in the conformal representation leading from the ideal to the particular surface, they give rise to cross-points.

We have then as a final result that *a greater freedom of choice has been obtained among the surfaces on which it is possible to operate and the accidental properties involved by the consideration of any particular surface can be at once recognized.* Consequently, many-sheeted surfaces over the $x + iy$ plane are henceforward employed whenever convenient, but this in no measure detracts from the generality of the results.*

§ 15. *The Anchor-ring, $p = 1$, and the two-sheeted Surface over the Plane with four Branch-points.*

It was possible in the preceding section to make our explanation comparatively brief as a knowledge of the ordinary Riemann's surface over the plane with its branch-points could be assumed. But it may nevertheless be useful to illustrate

*The interesting question here arises whether it is always possible to transform many-sheeted surfaces, with arbitrary branch-points, by a conformal process into surfaces with no singular points. This question transcends the limits of the subject under discussion in the text, but nevertheless I wish to bring it forward. Even if this transformation is impossible in individual cases, still the preceding discussion in the text is of importance, in that it led to general ideas by means of the simplest examples and thus rendered the treatment of more complicated occurrences possible.

these results by means of an example. Consider an anchor-ring, $p = 1$; on it there exist, by § 13, ∞^4 uniform functions with two infinities only; each of these, by the general formula of § 11, has four cross-points. The anchor-ring can therefore be mapped in an indefinite number of ways upon a two-sheeted plane surface with four branch-points. With a view to those readers who are not very familiar with purely intuitive operations, I give explicit formulæ for the special case of this representation which I am about to consider, even though, in so doing, I partly anticipate the work of the next section.

Imagine the anchor-ring as an ordinary tore generated by the rotation of a circle about a non-intersecting axis in its plane. Let ρ be the radius of this circle, R the distance of the centre from the axis, α the polar-angle.

Take the axis of rotation for axis of Z , the point O in the figure as origin for a system of rectangular coordinates, and distinguish the planes through OZ by means of the angle ϕ which they make with the positive direction of the axis of X . Then, for any point on the anchor-ring, we have,

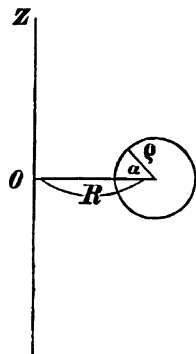

Fig. 34.

$$(1) \quad \begin{cases} X = (R - \rho \cos \alpha) \cos \phi, \\ Y = (R - \rho \cos \alpha) \sin \phi, \\ Z = \rho \sin \alpha. \end{cases}$$

Hence the element of arc is

$$(2) \quad \begin{aligned} ds &= \sqrt{dX^2 + dY^2 + dZ^2} \\ &= \sqrt{(R - \rho \cos \alpha)^2 d\phi^2 + \rho^2 d\alpha^2}, \end{aligned}$$

or,

$$(3) \quad ds = (R - \rho \cos \alpha) \sqrt{d\xi^2 + d\eta^2},$$

where ξ, η are written for $\phi, \int_0^\alpha \frac{\rho d\alpha}{R - \rho \cos \alpha}$.

By (3) we have a conformal representation of the surface of the anchor-ring on the $\xi\eta$ plane. The whole surface is obviously covered once when ϕ and α (in (1)) each range from $-\pi$ to $+\pi$. *The conformal representation of the surface of the anchor-ring therefore covers a rectangle of the plane, as in the following figure,*

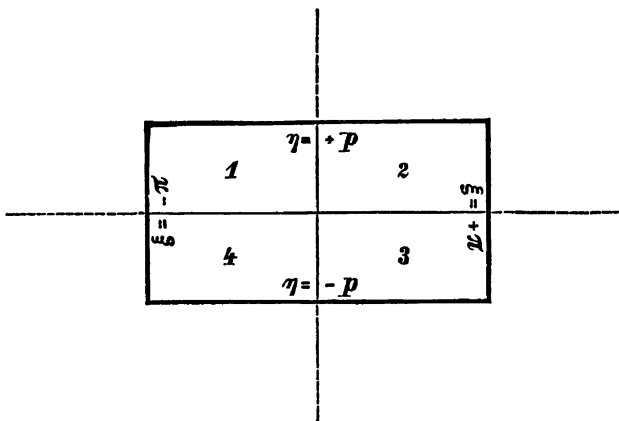

Fig. 35.

where p stands for

$$\int_0^\pi \frac{\rho d\alpha}{R - \rho \cos \alpha}.$$

To make the relation between the rectangle and the anchor-ring intuitively clear, imagine the former made of some material which is capable of being stretched and let the opposite edges of the rectangle be brought together without twisting. Or the anchor-ring may be made of a similar material, and after cutting along a curve of latitude and a meridian it can be stretched out over the $\xi\eta$ plane. Instead of further explanation I subjoin in a figure the projection of the anchor-ring from the positive end of the axis of Z upon the xy plane, and in this figure I have marked the relation to the $\xi\eta$ plane.

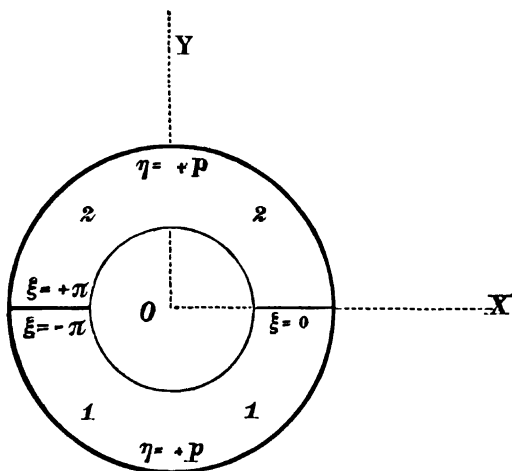

Fig. 36.

The upper surface of the anchor-ring is, of course, alone visible, the quadrants 3 and 4 on the under side are covered by 2 and 1 respectively.

Again, let a two-sheeted surface with four branch-points $z = \pm 1, \pm \frac{1}{\kappa}$ be given, where κ is real and < 1 , and imagine

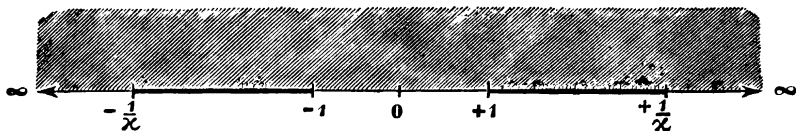

Fig. 37.

the two positive half-sheets of the plane to be shaded as in the figure. Let the branch-lines coincide with the straight lines between $+1$ and $\frac{1}{\kappa}$, and between -1 and $-\frac{1}{\kappa}$ respectively. This two-sheeted surface is known to represent the branching of $w = \sqrt{(1 - z^2) \cdot (1 - \kappa^2 z^2)}$ and by proper choice of branch-lines we can arrange that the real part of w shall be positive throughout the upper sheet. Now consider the integral

$$W = \int_0^z \frac{dz}{w}.$$

This also, as is well-known, gives a representation of the two-sheeted surface upon a rectangle, the relation between the two being given in detail in the following figure, where the shading and other divisions of Fig. 37 are reproduced. To the

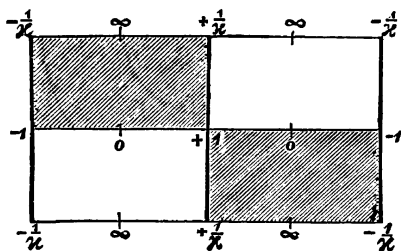

Fig. 38.

upper sheet of Fig. 37 corresponds the left side of this figure. The representation near the branch-points of the two-sheeted surface should be specially noticed.

It would perhaps be simplest to proceed first from Fig. 37 by stereographic projection to a doubly-covered sphere with four branch-points on a meridian—then to cut this surface along the meridian into four hemispheres, which by proper bending and stretching in the vicinity of the branch-points are then to be changed into plane rectangles—and lastly to place these four rectangles, in accordance with the relation among the four hemispheres, side by side as in Fig. 38. Moreover it is thus made evident that in Fig. 38 to one and the same point on the original surface correspond exactly *two* (associated) points on the edge. And now to arrive at the required relation between the anchor-ring and the two-sheeted surface we have only to ensure by proper choice of κ that the rectangle of Fig. 38 shall be *similar* to that of Fig. 35. A proportional

magnification of the one rectangle (which again is effected by a conformal deformation) will then make it exactly cover the other and the result is a uniform conformal representation of the two-sheeted surface upon the anchor-ring or *vice versa*. Here again it is sufficient to give a figure corresponding exactly to Fig. 36. The shading in this figure is confined to the

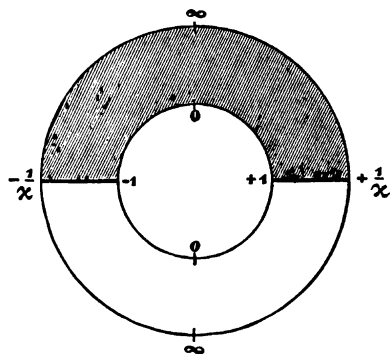

Fig. 39.

upper part of the anchor-ring; on the remainder, the lower half should be shaded while the upper half is blank.

The required conformal representation has thus been actually effected. Now, conversely, we will determine on the surface of the anchor-ring the streamings by means of which (according to § 14) the representation is brought about. There are cross-points at ± 1 , $\pm \frac{1}{\kappa}$, and algebraic infinities of unit multiplicity at the two points at ∞ . The equipotential curves and the stream-lines are most easily found by using the rectangle

as an intermediate figure. The curves $x = \text{const.}$, $y = \text{const.}$ of the z -plane, Fig. 37, obviously correspond on the rectangle of Fig. 38 to those shown in Fig. 40 and Fig. 41. The arrows are confined to the curves $y = \text{const.}$ to distinguish them as stream-lines.

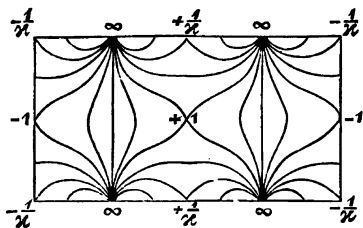

Fig. 40.

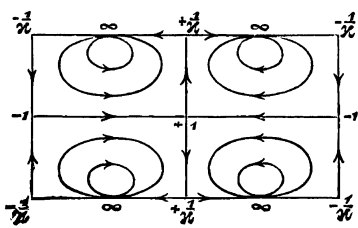

Fig. 41.

We have now only to treat these figures in the manner described for Fig. 35 and we obtain an anchor-ring and the required system of curves on its surface. The result is the following.

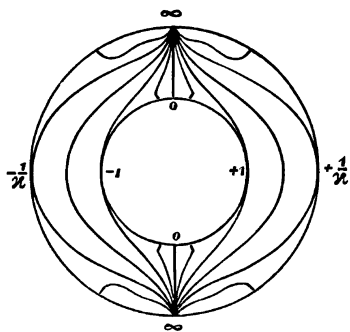

Fig. 42.

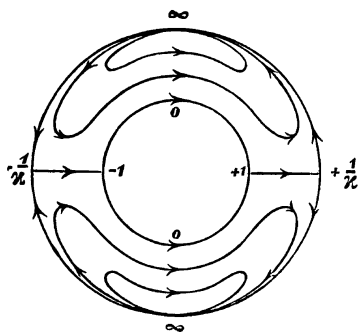

Fig. 43.

In Fig. 42, by reason of the method of projection, the four cross-points of the streaming appear as points of contact of the equipotential curves with the apparent rim of the anchor-ring.

§ 16. *Functions of $x + iy$ which correspond to the Streamings already investigated.*

Let $x + iy$, as in § 14, be a uniform complex function of position on the surface, with m simple algebraic infinities; let us transform the surface by the methods there given into an m -sheeted surface over the $x + iy$ plane* and let us then ask *into what functions of the argument $x + iy$ the complex functions of position we have hitherto investigated have been changed?* The results of § 6 should here be borne in mind.

First, let w be a complex function of position which, like $x + iy$, is *uniform* on the surface. From the assumptions respecting the infinities of the functions, and particularly those of uniform functions, it follows at once that w , as a function of $x + iy$, has no *essential* singularity. Again, w , on the m -sheeted surface as on the original surface, is uniform. Hence it follows by known propositions that w is an *algebraic function* of z .

We have here not excluded the possibility of the m values of w which correspond to the same z coinciding everywhere ν at a time (where ν must of course be a divisor of m). But it must be possible to choose functions w such that this may not be the case. We have already (§ 13) determined uniform

*This geometrical transformation is of course not essential; it merely preserves the connection with the usual presentations of the subject.

functions with arbitrarily assigned infinities; thus, to avoid the above contingency, we need only choose the infinities of w in such a way that no ν of them lead to the same z . Then we have:

The irreducible equation between w and z

$$f(w, z) = 0$$

is of the m th degree in w .

Similarly, it will be of the n th degree in z , if n is the sum of the orders of the infinities of w .

But the connection between the equation $f = 0$ and the surface is still closer than is shown by the mere agreement of the degree with the number of the sheets. To every point of the surface there belongs only *one* pair of values w, z , which satisfy the equation; and conversely, to every such pair of values there belongs, in general,* only one point of the surface. *Equation and surface are, so to speak, connected by a uniform relation.*

Now let w_1 be another uniform function on the surface; it is therefore certainly an algebraic function of z . Then, when once the equation $f(w, z) = 0$ has been formed, with the above assumption, the character of this algebraic function can be expressed in half a dozen words. *For it can be shown that w_1 is a rational function of w and z , and, conversely, that every rational function of w and z is a function with the characteristics of w_1 .* This last is self-evident. For a rational function

*In special cases this may not be so. If we regard w, z , as coordinates and interpret the equation between them by a curve, the double-points of this curve, as we know, correspond to these exceptional cases.

of w and z is uniform on the surface; moreover, as an analytical function of z , it is a complex function of position on the surface. The first part is easily proved. Let the m values of w belonging to a special value of z be $w^{(1)}, w^{(2)}, \dots, w^{(m)}$ (in general, $w^{(\alpha)}$) and the corresponding values of w_1 (which are not all necessarily distinct) $w_1^{(1)}, w_1^{(2)}, \dots, w_1^{(m)}$. Then the sum,

$$w_1^{(1)} w^{(1)\nu} + w_1^{(2)} w^{(2)\nu} + \dots + w_1^{(m)} w^{(m)\nu}$$

(where ν is an arbitrary integer, positive or negative), being a symmetric function of the various values $w_1^{(\alpha)} w^{(\alpha)\nu}$, is a uniform function of z , and therefore, being an algebraic function, is a *rational* function of z . From any m of such equations

$$w_1^{(1)}, w_1^{(2)}, \dots, w_1^{(m)},$$

being linearly involved, can be found, and it can easily be shown that each $w_1^{(\alpha)}$ is, as it should be, a rational function of the corresponding $w^{(\alpha)}$ and of z .

With the help of this proposition we can at once determine the character of those functions of z which arise from the *multiform* functions of position of which we have been treating. Let W be such a function. Then W must certainly be an analytical function of z ; we may therefore speak of a *differential coefficient* $\frac{dW}{dz}$, and this again is a complex function of position on the surface. Quà function of position it is necessarily uniform; for the multiformity of W is confined to constant moduli of periodicity, any multiples of which may be

additively associated with the initial value. Hence $\frac{dW}{dz}$ is, by what has just been proved, a rational function of w and z , and W is therefore the integral of such a function, viz.:

$$W = \int R(w, z) dz.$$

The converse proposition, that every such integral gives rise to a complex function of position on the surface belonging to the class of functions hitherto discussed, is self-evident on the grounds of a known argument which considers, on the one hand, the infinities of the integrals, on the other, the changes in the values of the integrals caused by alterations in the path of integration. It is not necessary to discuss this here at greater length.

We have now arrived at a well-defined result. *Having once determined the algebraical equation which defines the relation between z and w , where w is highly arbitrary, all other functions of position are given in kind; they are co-extensive in their totality with the rational functions of w and z and the integrals of such functions.*

A convenient example is the repeatedly considered case of the anchor-ring, $p = 1$, with, for z and w , the functions discussed in the last section, the function z being the one illustrated by Figs. 42, 43. The equation between these being simply

$$w^2 = (1 - z^2) \cdot (1 - \kappa^2 z^2),$$

the integrals $\int R(w, z) dz$ are those generally known as *elliptic integrals*. Among them, by § 12, there is one single integral,

“finite everywhere.” From the representation given in Fig. 38 it follows that this is no other than $\int \frac{dz}{w}$ there considered, the so-called *integral of the first kind*. The equipotential curves and stream-lines are shown in Figs. 21, 22. But the functions corresponding to Figs. 29, 30 and to Figs. 31, 32 are also familiar in ordinary analysis. In one case we have a function with two logarithmic discontinuities, in the other case one with one algebraic discontinuity. Regarded as functions of z these are the elliptic integrals usually called *integrals of the third kind*, and *integrals of the second kind* respectively.

§ 17. *Scope and Significance of the previous Investigations.*

The last section has actually accomplished the solution of the general problem indicated in § 7. The most general of the complex functions of position here treated of have been determined on an arbitrary surface, and the analytical relations among these have been defined by observation of the fact that all are dependent, in the sense of ordinary analysis, on a single, uniform, but otherwise arbitrarily chosen function of position. To complete the discussion, therefore, a synoptic review of the subject alone is wanting, to ascertain the total result of the investigation. We have obtained, though not the whole content, yet at least the principles of Riemann's theory, and for further deductions Riemann's original work as well as other presentations of the theory may be referred to.

First, to establish that *these investigations do actually*

comprehend the totality of algebraic functions and their integrals. For if any algebraical equation $f(w, z) = 0$ is given, we can construct, as usual, the proper many-sheeted surface over the z -plane, and on this we can then study the one-valued streamings and complex functions of position (cf. § 15).

We then enquire, is the knowledge of these functions really furthered by these investigations? In this connection we must remember that it was chiefly the multiplicity of value of the integrals which for so long hindered any advance in their theory. That integrals acquire a multiplicity of value when logarithmic discontinuities make their appearance had been already observed by Cauchy. But it was only through Riemann's surfaces that the other kind of periodicity was clearly brought to light,—that, namely, which has its origin in the *connectivity* of the surface, and is measured along the cross-cuts of that surface. Another point is this:—transformation by substitutions had long been employed in the examination of integrals, but without much more result than their mere empirical evaluation. In Riemann's theory an extensive class of substitutions presents itself automatically, and is to be critically examined in operation. The variables w, z , are merely any two independent, uniform functions of position; any other two, w_1, z_1 , can be equally well assumed as fundamental, whereby w_1, z_1 prove to be any rational, but otherwise arbitrary functions of w, z , and these in their turn to be rational functions of w_1, z_1 . The Riemann's surface is not necessarily affected by this change. Hence among the numerous *accidental* properties of the functions, we distinguish certain *essential* ones which are unaltered

by uniform transformations. And in the number p especially such an invariative element presents itself from the outset. Thus Riemann's theory, avoiding these two difficulties which had hampered former investigations, proceeds at once to determine in what way the functions in question are arbitrary. This was accomplished in § 10 by the proposition: *the infinities of the functions (with the restrictions we have assumed throughout) and the moduli of periodicity of its real part at the cross-cuts, are arbitrary and sufficient data for the determination of the function.*

This fairly represents the advantage gained by this treatment if, with most mathematicians, we place the interests of the theory of functions foremost. But it must be borne in mind that the opposite point of view is as fundamentally justifiable. The knowledge of one-valued streamings on given surfaces may with good reason be regarded as an end in itself, since in numerous *physical* problems it leads directly to a solution. Among the infinite possible varieties of these streamings Riemann's theory is a valuable guide for it indicates the connection between the streamings and the algebraic functions of analysis.

Finally, we may bring forward the geometrical side of the subject and consider Riemann's theory as a means of making the theory of the conformal representation of one closed surface upon another accessible to analytical treatment. The third part of this pamphlet is devoted to this view of the subject; it is unnecessary to dwell on it at present at greater length.

§ 18. *Extension of the Theory.*

In Riemann's own train of thought, as I have here attempted to show, the Riemann's surface not only provides an intuitive illustration of the functions in question, but it actually *defines* them. It seems possible to separate these two parts, to take the definition of the function from elsewhere and to retain the surface only as a means of intuitive illustration. This is, in fact, what has been done by most mathematicians, the more readily that Riemann's definition of a function involves considerable difficulties* when subjected to more exact scrutiny. They therefore usually begin with the algebraical equation and the definition of the integral and then construct the appropriate Riemann's surface.

But this method produces *ipso facto* a considerable generalisation of the original conception. Hitherto, two surfaces were only held to be equivalent when one could be derived from the other by a conformal representation with a uniform correspondence of points. Now there is no longer any reason for retaining the conformal character of the representation. *Every surface which by a continuous uniform transformation can be changed into the given surface, in fact any geometrical configuration whose elements can be projected upon the original surface by a continuous uniform projection, serves equally well to give a graphic representation of the functions in question.* I have, in former papers, followed out this idea in two different ways, to which I should like to refer.

*Cf. the remarks on this subject in the Preface.

On one occasion I used the conception of a normal surface (cf. § 8) which, although representative, was open to various modifications, and on this I attempted to illustrate the course of the functions in question by various graphical means.* The nets of polygons which I have repeatedly used† fall also under this head; these I constructed by means of an appropriate dissection of the Riemann's surface afterwards spread out over the plane. It need not here be discussed whether these figures, which in the first place are susceptible of continuous deformation, may not hereafter, for the sake of further investigations in the theory of functions, be restricted by a law of form whereby it may be possible to *define* the functions graphically represented by each figure.

On another occasion‡ I undertook to bring out as intuitively as possible the connection between the conceptions of the theory of functions and those of ordinary analytical geometry, in which last an equation in two variables means a *curve*. Starting from the proposition that every imaginary straight line on the plane, and therefore also every imaginary tangent to a curve, has one and only one real point, I obtained a Riemann's surface depending essentially on the course of the curve

*Cf. my papers on Elliptic Modular-functions in *Math. Ann.*, t. XIV., XV., XVII.

†Cf. especially the diagrams in *Math. Ann.*, t. XIV. ("Zur Transformation siebenter Ordnung der elliptischen Functionen"), and Dyck's paper, to be cited presently, *ib.*, t. XVII.

‡"Ueber eine neue Art Riemann'scher Flächen," *Math. Ann.*, t. VII., X.

at every point. These surfaces I have hitherto employed, following my original purpose, only to illustrate intuitively the behaviour of certain simple integrals.* But a remark similar to that on the nets of polygons may here be made. In so far as the surface is subjected to a law of form, it must be possible to use it as a *definition* of the functions which exist on it. And it is actually possible to form a partial differential equation for these functions somewhat analogous to the differential equation of the second order considered in §§ 1 and 5; except that the differential expression on which this equation depends cannot be directly interpreted by the element of arc.

These few remarks must suffice to indicate developments which appear to me worthy of consideration.

*See Harnack ("Ueber die Verwerthung der elliptischen Functionen für die Geometrie der Curven dritten Grades"), *Math. Ann.*, t. IX.; and my paper referred to above, "Ueber den Verlauf der Abel'schen Integrale bei den Curven vierten Grades," *Math. Ann.*, t. X.

PART III.

CONCLUSIONS.

§ 19. *On the Moduli of Algebraical Equations.*

In one important point, Riemann's theory of algebraic functions surpasses in results as well as in methods the usual presentations of this theory. It tells us that, *given graphically a many-sheeted surface over the z plane, it is possible to construct associated algebraic functions*, where it must be observed that these functions if they exist at all are of a highly arbitrary character, $R(w, z)$ having in general the same branchings as w . This theorem is the more remarkable, in that it implies a statement about an interesting equation of higher order. For if the branch-points of an m -sheeted surface are given, there is a finite number of essentially different possible ways of arranging these among the sheets; this number can be found by considerations belonging entirely to pure analysis situs.* But, by the above proposition this number has its algebraical meaning. Let us with Riemann speak of all algebraic functions of z as belonging to the same class when by means of z they can be rationally expressed in terms of one another. *Then the number in question[†] is the number of*

*This number has been determined by Herr Kasten, for instance, in his Inaugural Dissertation: *Zur Theorie der dreiblättrigen Riemann'schen Fläche*. Bremen, 1876.

[†]If I may be allowed to refer once more to my own writings, let me do so with respect to a passage in *Math. Ann.*, t. XII. (p. 173), which

different classes of algebraic functions which, with respect to z , have the given branch-values.

In the present and following sections various consequences are drawn from this preliminary proposition and among these we may consider in the first place the question of the *moduli* of the algebraic functions, *i.e.* of those constants which play the part of the invariants in a uniform transformation of the equation $f(w, z) = 0$.

For this purpose let ρ be a number initially unknown, expressing the number of degrees of freedom in any one-one transformation of a surface into itself, *i.e.* in a conformal representation of the surface upon itself. Then let us recall the number of available constants in uniform functions on given surfaces (§ 13). We found that there were in general ∞^{2m-p+1} uniform functions with m infinities and that this, as we stated without proof, is the exact number when $m > 2p-2$. Now each of these functions maps the given surface by a uniform transformation upon an m -sheeted surface over the plane. *Hence the totality of the m -sheeted surfaces upon which a given surface can be conformally mapped by a uniform transformation, and therefore also the number of m -sheeted surfaces with which an equation $f(w, z) = 0$ can be associated, is $\infty^{2m-p+1-\rho}$; for ∞^ρ representations give the same m -sheeted surface, by hypothesis.*

establishes the result that certain rational functions are fully determined by the number of their branchings, and again to *ib.*, t. XV., p. 533, where a detailed discussion shows that there are ten rational functions of the eleventh degree with certain branch-points.

But there are in all ∞^w m -sheeted surfaces, where w is the number of branch-points, *i.e.* $2m + 2p - 2$. For, as we observed above, the surface is given by the branch-points to within a finite number of degrees of freedom, and branch-points of higher multiplicity arise from coalescence of simple branch-points as we have already explained in connection with the corresponding cross-points in § 1 (cf. Figs. 2, 3). With each of these surfaces there are, as we know, algebraic functions associated. *The number of moduli is therefore*

$$w - (2m + 1 - p - \rho) = 3p - 3 + \rho.$$

It should be noticed here that the totality of m -sheeted surfaces with w branch-points form a *continuum*,* corresponding to the same fact, pointed out in § 13 with respect to uniform functions with m infinities on a given surface. Hence we conclude *that all algebraical equations with a given p form a single continuous manifoldness*, in which all equations derivable from one another by a uniform transformation constitute an individual element. Thus, for the first time, a precise meaning attaches itself to the number of the moduli; *it determines the dimensions of this continuous manifoldness.*

The number ρ has still to be determined and this is done by means of the following propositions.

1. *Every equation for which $p = 0$ can by means of a one-one relation be transformed into itself ∞^3 times.* For on the

*This follows *e.g.* from the theorems of Lüroth and of Clebsch, *Math. Ann.*, t. IV., v.

corresponding Riemann's surface uniform functions with one infinity only are triply infinite in number (§ 13), and in order that the transformation of the surface into itself may be uniform, it is sufficient to make any two of these correspond to each other. Or the proof may be more fully given as follows. If one function is called z , all the rest are (by § 16) algebraic and uniform, *i.e.* rational functions of z , and since the relation must be reciprocal, *linear* functions of z . Conversely every linear function of z is a uniform function of position on the surface having one infinity only. Hence the most general uniform transformation of the equation into itself is obtained by transforming every point of the Riemann's surface by means of the formula

$$z_1 = \frac{\alpha z + \beta}{\gamma z + \delta},$$

$\alpha : \beta : \gamma : \delta$ being arbitrary.

2. *Every equation for which $p = 1$ can be transformed into itself in a singly infinite number of ways.* For proof consider the integral W finite over the whole surface, and in particular the representation upon the W -plane of the Riemann's surface when properly dissected. This has already been done in a particular case (§ 15, Fig. 38) and a minute investigation of the general case is hardly necessary as the considerations involved are usually fully worked out in the theory of elliptic functions. The result is that to every value of W belongs one and only one point of the Riemann's surface, while the infinitely many values of W corresponding to the same point of the Riemann's surface can be constructed from one of these values in the form

$W + m_1\omega_1 + m_2\omega_2$, where m_1, m_2 are any integers and ω_1, ω_2 are the periods of the integral. For a uniform deformation a point W_1 must be associated with each point W in such a way that every increase of W by a period gives rise to a similar increase of W_1 and *vice versa*. This is certainly possible, but in general only by writing $W_1 = \pm W + C$; in special cases (when the ratio of the periods $\frac{\omega_1}{\omega_2}$ possesses certain properties belonging to the theory of numbers) W_1 may also $= \pm iW + C$ or $\pm \rho W + C$ (ρ being a third root of unity).^{*} However that may be we have in each case in the formulæ of transformation only one arbitrary constant and hence corresponding to its different values we have a singly infinite number of transformations, as stated above.

3. *Equations for which $p > 1$ cannot be changed into themselves in an infinite number of ways.*[†] For the analytical proof of this statement I refer to Schwarz (*Crelle*, t. LXXXVII.) and to Hettner (*Gött. Nachr.*, 1880, p. 386). By intuitive methods the correctness of the statement may be shown as follows. If there were an infinite number of uniform transformations of the equation into itself, it would be possible to displace the Riemann's surface continuously over itself in such a way that

^{*}This result, which is well known from the theory of elliptic functions, is stated in the text without proof.

[†]This theorem refers to a *continuous* group of transformations, those with arbitrarily variable parameters. It is not discussed in the text whether, under certain circumstances, a surface for which $p > 1$ may not be transformed into itself by an infinite number of *discrete* transformations; though when p is finite in value this also seems to be impossible.

every smallest part should remain similar to itself. The curves of displacement must plainly cover the surface completely and at the same time simply; there can be no *cross-point* in this system, for such a point would have to be regarded as a stationary point in order to avoid multiformity in the transformation and the rate of displacement would there necessarily be zero. But then an infinitesimal element of surface approaching the cross-point in the course of the displacement would necessarily be compressed in the direction of motion and perpendicular to that direction it would be stretched; it could therefore not remain similar to itself, contrary to the conception of conformal representation. But on the other hand all systems of curves covering a surface for which $p > 1$ completely and simply must have cross-points; this is the proposition proved in somewhat less general form in § 11. The continuous displacement of the surface over itself is thus impossible, as was to be proved.

By these propositions, $\rho = 3$ for $p = 0$, $\rho = 1$ for $p = 1$, and for all greater values of p , $\rho = 0$. *The number of moduli is therefore, for $p = 0$ zero, for $p = 1$ one, and for $p > 1$ $3p - 3$.*

It may be worth while to add the following remarks. To determine a point in a space of $3p - 3$ dimensions we do not generally confine ourselves to $3p - 3$ coordinates; more are employed connected by algebraical, or transcendental relations. But moreover it is occasionally convenient to introduce parameters, of which different series denote the same point of the manifoldness. The relations which then hold among the $3p - 3$ moduli necessarily existing for $p > 1$ have been but little investigated. On the other hand the theory of elliptic

functions has given us an exact knowledge of the subject for the case $p = 1$. I mention the results for this case in order to be able to express myself precisely and yet briefly in what follows. Above all let me point out that for $p = 1$ the algebraical element (to use the expression employed above) is actually distinguished by one and only one quantity: *the absolute invariant* $J = \frac{g_2^2}{\Delta}$.^{*} Whenever, in what follows, it is said that in order to transform two equations for which $p = 1$ into each other it is not only sufficient but also necessary that the moduli should be equal, the invariant J is always meant. In its place, as we know, it is usual to put Legendre's κ^2 , which, given J , is six-valued, so that by its use a certain clumsiness in the formulation of general propositions is inevitable. And it is even worse if the ratio of the periods $\frac{\omega_1}{\omega_2}$ of the elliptic integral of the first kind is taken for the modulus, though this is convenient in other ways; for an infinite number of values of the modulus then denote the same algebraical element.

§ 20. *Conformed Representation of closed Surfaces upon themselves.*

In accordance with our original plan we now develop the geometrical side of the subject, in order to obtain at least the foundations of the theory of conformal representation of sur-

^{*}Cf. *Math. Ann.*, t. XIV., pp. 112 *et seq.*

faces upon each other,* so following up the indications which, as we have already remarked in the Preface, were given by Riemann at the close of his Dissertation. For the cases $p = 0$, $p = 1$, I shall for the most part, to avoid diffuseness, confine myself to mere statements of results or indications of proofs. And first, in treating of the conformal representations of a closed surface upon itself, a distinction which has been hitherto ignored must be introduced: *the representation may be accomplished without or with reversal of angles*. We have an example of the first case when a sphere is made to coincide with itself by rotation about its centre; of the second case when it is reflected across a diametral plane with the same result. The analytical treatment hitherto employed corresponds to representations of the first kind only. If $u + iv$ and $u_1 + iv_1$ are two complex functions of position on the same surface, $u = u_1$, $v = v_1$ gives the most general representation of the first kind (cf. § 6). But it is easy to see how to extend the formula in order to include representations of the second kind as well. *We have simply to write $u = u_1$, $v = -v_1$ in order to obtain a representation of the second kind.*

*The theorems to be established in the text are, for the most part, not explicitly given in the literature of the subject. For the surfaces for which $p = 0$, compare Schwarz's memoir (*Berl. Monatsber.*, 1870), already cited. And, further, a paper by Schottky: *Ueber die conforme Abbildung mehrfach zusammenhängender Flächen*, which appeared in 1875 as a Berlin Inaugural Dissertation and was reprinted in a modified form in *Crelle*, t. LXXXIII. It treats of those plane surfaces of connectivity p which have $p + 1$ boundaries.

Let us first take from the theorems of the last section those parts which refer to representations of the first kind; in the most geometrical language possible we have then the following theorems:

It is always possible to transform into themselves in an infinite number of ways by a representation of the first kind surfaces for which $p = 0$, $p = 1$, but never surfaces for which $p > 1$.

For the surfaces for which $p = 0$ the only representation of the first kind is determined if three arbitrary points of the surface are associated with three other arbitrary points of the same.

If $p = 1$, to any arbitrary point of the surface a second point may be arbitrarily assigned, and there is then in general a two-fold possibility of determination of the representation of the first kind, though in special cases there may be a four-fold or six-fold possibility.

These propositions of course do not exclude the possibility that special surfaces for which $p > 1$ may be transformed into themselves by *discontinuous* transformations of the first kind. If this occurs it constitutes an invariative property for any conformal deformation of the surface and by its existence and modality specially interesting classes of surfaces may be distinguished from the remainder.* This point of view, however,

*Algebraical equations with a group of uniform transformations into themselves correspond to these surfaces. The observations in the text thus refer to investigations such as those lately undertaken by Herr Dyck (cf. *Math. Ann.*, t. XVII., "Aufstellung und Untersuchung von Gruppe

need not be discussed more fully here.

With respect to the transformations of the second kind we may first say that *every such transformation, combined with one of the first kind, produces a new transformation of the second kind.* Now by the above theorems we have complete knowledge of the transformations of the first kind for surfaces for which $p = 0$, $p = 1$; in these cases therefore it suffices to enquire whether *one* transformation of the second kind exists. *For the surfaces for which $p = 0$ this is at once answered in the affirmative.* For it is sufficient to take any one of the uniform functions of position with only one infinity, $x + iy$, and then to write $x_1 = x$, $y_1 = -y$. For the surfaces for which $p = 1$ the case is different. *We find that in general no transformation of the second kind exists.* The easiest way to prove this is to consider the values which the integral W , finite over the whole surface, assumes on the anchor-ring, $p = 1$. Let the points $W = m_1\omega_1 + m_2\omega_2$ be marked on the W plane, m_1, m_2 being as before arbitrary positive or negative integers. It is then easily shown that a transformation of the second kind can change the surface for which $p = 1$ into itself only if this system of points has an axis of symmetry. This case occurs when the invariant J , defined above, is *real*; according as J is < 1 or > 1 , these points in the W plane are corners of a rhomboidal or rectangular system.

Now let $p > 1$. If one transformation of the second kind exists for this surface, there will in general be no other of

und Irrationalität regulärer Riemann'scher Flächen").

the same kind.* For otherwise the repetition or combination of these transformations would produce a transformation of the first kind distinct from the identical transformation. The transformation must then necessarily be *symmetrical*, *i.e.* it must connect the points of the surface in *pairs*. The surface itself will for this reason be called *symmetrical*. Moreover under this name I shall in future include all those surfaces for which there exists a transformation of the second kind leading, when repeated, to identity. To this class belong evidently all surfaces for which $p = 0$, and such surfaces for which $p = 1$ as have real invariants.

§ 21. *Special Treatment of symmetrical Surfaces.*

Among the symmetrical surfaces now to be considered, divisions at once present themselves according to the number and kind of the “*curves of transition*” on the surfaces; *i.e.* of those curves whose points remain unchanged during the symmetrical transformation in question.

The number of these curves can in no case exceed $p + 1$. For if a surface is cut along all its curves of transition with the exception of one, it will still remain an undivided whole, the symmetrical halves hanging together along the one remaining curve of transition. Thus if there were more than $p + 1$ of

*There are, of course, surfaces capable of a certain number of transformations of the first kind, together with an equal number of transformations of the second kind; these correspond to the *regular symmetrical* surfaces of Dyck's work.

these, more than p loop-cuts in the surface could be effected without resolving it into distinct portions, thus contradicting the definition of p .

On the other hand there may be any number of curves of transition below this limit. It will be sufficient here to discuss the cases $p = 0$, $p = 1$; for the higher p 's examples will present themselves naturally.

(1) When a sphere is made to coincide with itself by reflection in a diametral plane, the great circle by which the diametral plane cuts it, is the *one* curve of transition. An example of the other kind is obtained by making every point of the sphere correspond to the point at the opposite end of its diameter. Both examples can be easily generalised; the analysis is as follows. If one curve of transition exists, there are uniform functions of position with only one infinity, which assume real values at all points of the curve of transition. If one of these functions is $x + iy$ the transformation, already given as an example above, is $x_1 = x$, $y_1 = -y$. For the second case, a function $x + iy$ can be so chosen that ∞ and 0, and +1 and -1, are corresponding points. Then

$$x_1 - iy_1 = \frac{-1}{x + iy}$$

is the analytical formula for the corresponding transformation.

(2) In the case $p = 1$, the invariant J must in the first place, as we know, be assumed to be real. First, let it be > 1 . Then the integral W , which is finite over the whole surface, can be reduced to a normal form by the introduction of an

appropriate constant factor in such a manner that one period becomes *real* = a and the other *purely imaginary* = ib . If we then write

$$U_1 = U, \quad V_1 = V, \quad \text{in} \quad W = U + iV,$$

we obtain a symmetrical transformation of the surface for which $p = 1$, with the *two* curves of transition,

$$V = 0, \quad V = \frac{b}{2},$$

but if we write

$$U_1 = U + \frac{a}{2}, \quad V_1 = -V,$$

which again is a symmetrical transformation of the original surface, we have the case in which there is *no* curve of transition. The case with only *one* curve of transition occurs when $J < 1$. W can then be so chosen that its two periods are conjugately complex. We write, as before,

$$U_1 = U, \quad V_1 = -V,$$

and obtain a symmetrical transformation with the *one* curve of transition, $V = 0$.

Besides this first division of symmetrical surfaces according to the *number* of the curves of transition there is yet a second. The cases of no curves of transition and of $p + 1$ curves of transition are to be excluded for one moment. Then a two-fold

possibility presents itself: *Dissection of the surface along all the curves of transition may or may not resolve it into distinct portions.* Let π be the number of curves of transition. It is easily shown that $p - \pi$ must be uneven if the surface is resolved into distinct portions; that there is no further limitation may be shown by examples. We shall therefore distinguish between symmetrical surfaces of one kind or of the other and count the surfaces with $p + 1$ curves of transition among the first kind—those that are resolved into distinct portions—and the surfaces with no curves of transition among the second kind.

These propositions have a certain analogy with the results obtained in analytical geometry by investigating the forms of curves with a given p .* And in fact we see that this analogy is justified. Analytical geometry is (primarily) concerned only with equations, $f(w, z) = 0$, with real coefficients. Let us first observe that every such equation determines a symmetrical Riemann's surface over the z -plane, inasmuch as the equation, and therefore the surface, remains unchanged if w and z are simultaneously replaced by their conjugate values, and that the curves of transition on this surface correspond to the *real* series of values of w, z , which satisfy $f = 0$, *i.e.* to the various circuits of the curve $f = 0$, in the sense of analytical geometry.

But the converse is also easily obtained. Let a symmetrical

*Cf. Harnack, "Ueber die Vieltheiligkeit der ebenen algebraischen Curven," *Math. Ann.*, t. x., pp. 189 *et seq.*; cf. also pp. 415, 416, *ib.* where I have given the two divisions of those curves. It is perhaps as well in these investigations to start from the symmetrical surfaces and Riemann's Theory as presented in the text.

surface, and on it any arbitrary complex function of position, $u + iv$, be given. The symmetrical deformation causes a reversal of angles on the surface. If then to every point of the surface values u_1, v_1 , are ascribed equal to those u, v , given by the symmetrical point, $u_1 - iv_1$ will be a new complex function of position. Now construct

$$U + iV = (u + u_1) + i(v - v_1),$$

so obtaining an expression which in general does not vanish identically; to ensure this, it is sufficient to assume that the infinities of $u + iv$ are unsymmetrically placed. *We have then a complex function of position with equal real parts, but equal and opposite imaginary parts at symmetrically placed points.* Of such functions, $U + iV$, let any two, W, Z , be taken, these being moreover *uniform* functions of position. The algebraical equation existing between these two has then the characteristic of remaining unaltered if W, Z are simultaneously replaced by their conjugate values. *It is therefore an equation with real coefficients* and the required proof has been obtained.

I supplement this discussion with a few remarks on the *real* uniform transformations of *real* equations $f(w, z) = 0$ into themselves, or, what amounts to the same thing, on conformal representations, of the first kind, of symmetrical surfaces upon themselves, in which symmetrical points pass over into other symmetrical points. Such transformations, by the general proposition of § 19, can occur in infinite number only for $p = 0, p = 1$; we therefore confine ourselves to these cases. Let

us first take $p = 1$. Then we see at once that among the transformations already established, we need now only consider the one

$$W_1 = \pm W + C,$$

where C is a real constant. Similarly when $p = 0$, for the first case. The relations $x_1 = x$, $y_1 = -y$ remain unaltered if

$$x + iy = z \quad \text{and} \quad x_1 + iy_1 = z_1$$

are simultaneously transformed by the substitution

$$z' = \frac{\alpha z + \beta}{\gamma z + \delta},$$

where the ratios $\alpha : \beta : \gamma : \delta$ are real. When $p = 0$, for the second case, the matter is rather more complicated. *Similar transformations with three real parameters are again possible*; but these assume the following form, z being the same as above,

$$z' = \frac{(a + ib)z + (c + id)}{-(c - id)z + (a - ib)},$$

where $a : b : c : d$ are the three real parameters. This result is implicitly contained in the investigations referring to the analytical representation of the rotations of the $x + iy$ sphere about its centre.*

*Cf. Cayley, "On the correspondence between homographies and rotations," *Math. Ann.*, t. xv., pp. 238-240.

§ 22. *Conformal Representation of different closed Surfaces upon each other.*

If we now wish to map different closed surfaces upon each other, the foregoing investigation of the conformal representation of closed surfaces upon themselves will give us the means of determining how often such a representation can occur, if it is once possible. Surfaces which can be conformally represented upon each other certainly possess (as has been already pointed out) transformations into themselves, consistent with these. Thus all representations of the one surface upon the other are obtained by combining one arbitrary representation with all those which change *one* of the given surfaces into itself. To this I need not return.

Let us first consider general, *i.e.* non-symmetrical surfaces. Then the enumerations of the moduli of algebraical equations given in § 19 are at once applicable.

We have first: *Surfaces for which $p = 0$ can always be conformally represented upon each other*, and we find besides that surfaces for which $p = 1$ have one modulus, surfaces for which $p > 1$, $3p - 3$ moduli, unaltered by conformal representation. Every such modulus is in general a *complex* constant. Since in the case of symmetrical surfaces real parameters alone must be considered, we shall suppose the modulus to be separated into its real and imaginary parts. Then we have: *If two surfaces for which $p > 0$ can be represented upon each other there must exist equations among the real constants of the surface, 2 for $p = 1$, and $6p - 6$ for $p > 1$.*

Turning now to the *symmetrical* surfaces, we must make one preliminary remark. It is evident that two such surfaces can be “symmetrically” projected upon one another only if they have, as well as the same p , the same number π of curves of transition, and moreover if they both belong either to the first or to the second kind. The enumeration in § 13 of the number of constants in uniform functions is now to be made over again, with the special condition required for symmetrical surfaces that those functions only are to be considered whose values at symmetrical places are conjugately imaginary. And then, as in § 19, we must combine with this the number of those many-sheeted surfaces which can be spread over the z -plane and are symmetrical with respect to the axis of real quantities. To avoid an infinite number of transformations into themselves, I will here assume $p > 1$. The work is then so simple that I do not need to reproduce it for this special case. The only difference is that those constants which were before perfectly free from conditions must now be *either every one real or else conjugately complex in pairs*. Hence all the arbitrary quantities are reduced to half the number. This may be stated as follows: *In order that it may be possible to represent two symmetrical surfaces for which $p > 1$ upon one another, it is necessary that, over and above the agreement of attributes, $3p - 3$ equations should subsist among the real constants of the surface.*

The cases $p = 0$, $p = 1$, which were here excluded, are implicitly considered in the preceding section. Of course two symmetrical surfaces for which $p = 1$ which are to be rep-

resented upon one another must have the same invariant J , giving *one* condition for the constants of the surface, inasmuch as J is certainly real. But besides this we find at once that the representation is always possible, so long as the symmetrical surfaces agree in the *number of curves of transition*, a condition which is obviously always necessary.

§ 23. *Surfaces with Boundaries and unifacial Surfaces.*

By means of the results just obtained an apparently important generalisation may be made in the investigation of the representations of *closed* surfaces, and it was for the sake of this generalisation that symmetrical surfaces were discussed in so much detail. For surfaces *with boundaries* and *unifacial surfaces* (which may or may not be bounded) may now be taken into account and the problems referring to them all solved at once. With reference to the introduction of boundaries here, a certain limitation hitherto implicitly accepted must be removed. The surfaces employed have been all assumed to be of continuous curvature or at least to have discontinuities at isolated points only (the branch-points). But there is now no reason against the admission of other discontinuities. For instance, we may suppose that the surface is made up of a finite number of different pieces (in general, of various curvatures) which meet at finite angles after the manner of a polyhedron; for there is nothing to prevent the conception of electric currents on these surfaces as well as on those of continuous curvature. Now surfaces with boundaries are included among such

surfaces.* For let the two sides of the bounded surface be conceived to be two faces of a polyhedron meeting along a boundary (and therefore everywhere at an angle of 360°), and employ the *total surface* composed of these two faces instead of the original bounded surface.†

This total surface is then in fact a closed surface; but it is moreover symmetrical, for if the points which lie one above the other are interchanged, the total surface undergoes a conformal transformation into itself, the angles being reversed; the boundaries are here the curves of transition. *But at the same time the division of symmetrical surfaces into two kinds obtains an important significance.* The usual bounded surfaces, in which the two sides are distinguishable, evidently correspond to the first kind; but unifacial surfaces, in which it is possible to pass continuously from one side to the other on the surface itself, belong to the second kind. The case, above mentioned, in which the unifacial surface has no boundary has also to be considered. *It is a symmetrical surface without a curve of transition.*

Let us now consider in order the various cases to be distinguished.

*I owe this idea to an opportune conversation with Herr Schwarz (Easter, 1881). Compare Schottky's paper, already cited, *Crelle*, t. LXXXIII., and Schwarz's original investigations in the representations of closed polyhedral surfaces upon the sphere. (*Berl. Monatsber.*, 1865, pp. 150 *et seq.* *Crelle*, t. LXX., pp. 121–136, t. LXXV., p. 330.)

†I express myself in the text, for brevity, as if the original surface were bifacial, but the case of unifacial surfaces is not to be excluded.

(1) *First, let a simply-connected surface with one boundary be given.* This surface now appears as a closed surface for which $p = 0$, which, since there is a curve of transition, can be symmetrically represented upon itself. *We find therefore that two such surfaces can always be conformally represented upon one another by transformations of either kind, and that there are always three real disposable constants.* These can be employed to make an arbitrary interior point on the one surface correspond to an arbitrary interior point on the other surface and also an arbitrary point on the boundary of one to an arbitrary point on the boundary of the other. This method of determination corresponds to the well-known proposition concerning the conformal representation of a simply-connected *plane* surface with one boundary upon the surface of a circle, given by Riemann, and explained at length in No. 21 of his Dissertation as an example of the application of his theory to problems of conformal representation.

(2) *Further we consider unifaceal surfaces for which $p = 0$, with no boundaries.* From §§ 21, 22 it follows at once that two such surfaces can always be conformally represented upon one another and that there still remain (by the formulæ at the end of § 21) three real disposable constants.

(3) *The different cases arising from a total surface for which $p = 1$, may be considered together.* These include, first, the *doubly-connected surfaces with two boundaries*, that is, surfaces which in the simplest form may be thought of as closed ribbons; and, next, the well-known *unifaceal surfaces with only one boundary*, obtained by bringing together the two ends of

a rectangular strip of paper after twisting it through an angle of 180° . Finally, certain *unifacial surfaces with no boundaries* belong to this class. An idea of these may be formed by turning one end of a piece of india-rubber tubing inside out and then making it pass through itself so that the outer surface of one end meets the inner surface of the other. With reference to all these surfaces it has been established by former propositions that the representation of one surface upon another of the same kind is possible if *one*, but only one, equation exists among the real constants of the surface; and that the representation, if possible at all, is possible in an infinite number of ways, since a double sign and a real constant remain at our disposal.

(4) *We now take the general case of a bifacial surface.* The surface has π boundaries and admits moreover of p' loop-cuts which do not resolve it into distinct portions, where either p' must be > 0 , or $\pi > 2$. Then the total surface composed of the upper and under sides admits of $2p' + \pi - 1$ loop-cuts which leave it still connected; for first the p' possible loop-cuts can be effected twice over (on the upper, as well as on the under side), and then cuts may be made along $\pi - 1$ of the boundaries, and the total surface is still simply-connected. We will therefore write $p = 2p' + \pi - 1$ in the theorems of the foregoing section and we have the following theorem: *Two surfaces of the kind in question can be represented upon each other, if at all, only in a finite number of ways. The transformation depends on $6p' + 3\pi - 6$ equations among the real constants of the surface.*

(5) *We have, finally, the general case of unifacial surfaces*

with π boundaries and P other possible loop-cuts when the surface is considered as a bifacial total surface. Leaving aside the three cases given in (1), (2), and (3) ($P = 0$, $\pi = 0$ or 1 , and $P = 1$, $\pi = 0$) we have the same proposition as in (4) only that for $2p' + \pi - 1$ we must write $P + \pi$, where p may be odd or even. *In particular, the number of real constants of a unifacial surface which are unchanged by conformal transformation is*

$$3P + 3\pi - 3.$$

The general theorems and discussions given by Herr Schotky in the paper we have repeatedly cited, are all included in these results as special cases.

§ 24. *Conclusion.*

The discussion in this last section now drawing to its conclusion is, as we have repeatedly mentioned, intended to correspond to the indications given by Riemann at the close of his Dissertation. It is true we have here confined ourselves to uniform correspondence between two surfaces by means of conformal representation, whereas Riemann, as he explicitly states, was also thinking of multiform correspondence. For this case it would be necessary to imagine each of the surfaces covered by several sheets and to find then a conformal relation establishing uniform correspondence between the many-sheeted surfaces so obtained. For every branch-point which these surfaces might possess a new complex constant would be at our disposal.

It may here be remarked that we have already considered in detail at least *one* case of such a relation. When an arbitrary surface is spread over the plane in several sheets (§ 15), there is established between the surface and plane a correspondence which is multiform on one side. Further we may point out that by means of this special case two arbitrary surfaces are in fact connected by a relation establishing a multiform correspondence. For if the two surfaces are each represented on the plane, then, by means of the plane, there is a relation between them. The subject of multiform correspondence is of course by no means exhausted by these remarks. But we have laid a foundation for its treatment by showing its connection with Riemann's other speculations in the Theory of Functions, to an account of which these pages have been devoted.

GLOSSARY OF TECHNICAL TERMS.

The numbers refer to the pages.

- Bifacial, *zweiseitig*, 101
Boundary, *Randcurve*, 31
Branch-line, *Verzweigungsschnitt*, 61
Branch-point, *Verzweigungspunct*, 59
Circuit, *Ast, Zug*, 57
Circulation, *Wirbel*, 9
Conformal representation, *conforme Abbildung*, 21
Cross-cut, *Querschnitt*, 31
Cross-point, *Kreuzungspunct*, 4
Curve of transition, *Uebergangscurve*, 90
Equipotential curve, *Niveaucurve*, 2
Essential singularity, *wesentlich singuläre Stelle*, 6
Loop-cut, *Rückkehrschnitt*, 31
Modulus, *absoluter Betrag*, 10
Multiform, *vieldeutig*, 37
Normal surface, *Normalfläche*, 33
One-valued, *einförmig*, 29
Source, *Quelle*, 8
Steady streaming, *stationäre Strömung*, 2
Stream-line, *Strömungscurve*, 2
Strength, *Ergiebigkeit*, 8
Total surface, *Gesamtfläche*, 99
Unifacial surface, *Doppelfläche*, 98
Uniform, *eindeutig*, 3
Vortex-point, *Wirbelpunct*, 8

End of the Project Gutenberg eBook of On Riemann's Theory of Algebraic Functions and their Integrals, by Felix Klein

*** END OF THIS PROJECT GUTENBERG EBOOK ON RIEMANN'S THEORY ***

***** This file should be named 36959-pdf.pdf or 36959-pdf.zip *****
This and all associated files of various formats will be found in:
<http://www.gutenberg.org/3/6/9/5/36959/>

Produced by Andrew D. Hwang

Updated editions will replace the previous one--the old editions will be renamed.

Creating the works from public domain print editions means that no one owns a United States copyright in these works, so the Foundation (and you!) can copy and distribute it in the United States without permission and without paying copyright royalties. Special rules, set forth in the General Terms of Use part of this license, apply to copying and distributing Project Gutenberg-tm electronic works to protect the PROJECT GUTENBERG-tm concept and trademark. Project Gutenberg is a registered trademark, and may not be used if you charge for the eBooks, unless you receive specific permission. If you do not charge anything for copies of this eBook, complying with the rules is very easy. You may use this eBook for nearly any purpose such as creation of derivative works, reports, performances and research. They may be modified and printed and given away--you may do practically ANYTHING with public domain eBooks. Redistribution is subject to the trademark license, especially commercial redistribution.

*** START: FULL LICENSE ***

THE FULL PROJECT GUTENBERG LICENSE
PLEASE READ THIS BEFORE YOU DISTRIBUTE OR USE THIS WORK

To protect the Project Gutenberg-tm mission of promoting the free distribution of electronic works, by using or distributing this work

(or any other work associated in any way with the phrase "Project Gutenberg"), you agree to comply with all the terms of the Full Project Gutenberg-tm License (available with this file or online at <http://gutenberg.org/license>).

Section 1. General Terms of Use and Redistributing Project Gutenberg-tm electronic works

1.A. By reading or using any part of this Project Gutenberg-tm electronic work, you indicate that you have read, understand, agree to and accept all the terms of this license and intellectual property (trademark/copyright) agreement. If you do not agree to abide by all the terms of this agreement, you must cease using and return or destroy all copies of Project Gutenberg-tm electronic works in your possession. If you paid a fee for obtaining a copy of or access to a Project Gutenberg-tm electronic work and you do not agree to be bound by the terms of this agreement, you may obtain a refund from the person or entity to whom you paid the fee as set forth in paragraph 1.E.8.

1.B. "Project Gutenberg" is a registered trademark. It may only be used on or associated in any way with an electronic work by people who agree to be bound by the terms of this agreement. There are a few things that you can do with most Project Gutenberg-tm electronic works even without complying with the full terms of this agreement. See paragraph 1.C below. There are a lot of things you can do with Project Gutenberg-tm electronic works if you follow the terms of this agreement and help preserve free future access to Project Gutenberg-tm electronic works. See paragraph 1.E below.

1.C. The Project Gutenberg Literary Archive Foundation ("the Foundation" or PGLAF), owns a compilation copyright in the collection of Project Gutenberg-tm electronic works. Nearly all the individual works in the collection are in the public domain in the United States. If an individual work is in the public domain in the United States and you are located in the United States, we do not claim a right to prevent you from copying, distributing, performing, displaying or creating derivative works based on the work as long as all references to Project Gutenberg are removed. Of course, we hope that you will support the Project Gutenberg-tm mission of promoting free access to electronic works by

freely sharing Project Gutenberg-tm works in compliance with the terms of this agreement for keeping the Project Gutenberg-tm name associated with the work. You can easily comply with the terms of this agreement by keeping this work in the same format with its attached full Project Gutenberg-tm License when you share it without charge with others.

1.D. The copyright laws of the place where you are located also govern what you can do with this work. Copyright laws in most countries are in a constant state of change. If you are outside the United States, check the laws of your country in addition to the terms of this agreement before downloading, copying, displaying, performing, distributing or creating derivative works based on this work or any other Project Gutenberg-tm work. The Foundation makes no representations concerning the copyright status of any work in any country outside the United States.

1.E. Unless you have removed all references to Project Gutenberg:

1.E.1. The following sentence, with active links to, or other immediate access to, the full Project Gutenberg-tm License must appear prominently whenever any copy of a Project Gutenberg-tm work (any work on which the phrase "Project Gutenberg" appears, or with which the phrase "Project Gutenberg" is associated) is accessed, displayed, performed, viewed, copied or distributed:

This eBook is for the use of anyone anywhere at no cost and with almost no restrictions whatsoever. You may copy it, give it away or re-use it under the terms of the Project Gutenberg License included with this eBook or online at www.gutenberg.org

1.E.2. If an individual Project Gutenberg-tm electronic work is derived from the public domain (does not contain a notice indicating that it is posted with permission of the copyright holder), the work can be copied and distributed to anyone in the United States without paying any fees or charges. If you are redistributing or providing access to a work with the phrase "Project Gutenberg" associated with or appearing on the work, you must comply either with the requirements of paragraphs 1.E.1 through 1.E.7 or obtain permission for the use of the work and the Project Gutenberg-tm trademark as set forth in paragraphs 1.E.8 or 1.E.9.

1.E.3. If an individual Project Gutenberg-tm electronic work is posted with the permission of the copyright holder, your use and distribution must comply with both paragraphs 1.E.1 through 1.E.7 and any additional terms imposed by the copyright holder. Additional terms will be linked to the Project Gutenberg-tm License for all works posted with the permission of the copyright holder found at the beginning of this work.

1.E.4. Do not unlink or detach or remove the full Project Gutenberg-tm License terms from this work, or any files containing a part of this work or any other work associated with Project Gutenberg-tm.

1.E.5. Do not copy, display, perform, distribute or redistribute this electronic work, or any part of this electronic work, without prominently displaying the sentence set forth in paragraph 1.E.1 with active links or immediate access to the full terms of the Project Gutenberg-tm License.

1.E.6. You may convert to and distribute this work in any binary, compressed, marked up, nonproprietary or proprietary form, including any word processing or hypertext form. However, if you provide access to or distribute copies of a Project Gutenberg-tm work in a format other than "Plain Vanilla ASCII" or other format used in the official version posted on the official Project Gutenberg-tm web site (www.gutenberg.org), you must, at no additional cost, fee or expense to the user, provide a copy, a means of exporting a copy, or a means of obtaining a copy upon request, of the work in its original "Plain Vanilla ASCII" or other form. Any alternate format must include the full Project Gutenberg-tm License as specified in paragraph 1.E.1.

1.E.7. Do not charge a fee for access to, viewing, displaying, performing, copying or distributing any Project Gutenberg-tm works unless you comply with paragraph 1.E.8 or 1.E.9.

1.E.8. You may charge a reasonable fee for copies of or providing access to or distributing Project Gutenberg-tm electronic works provided that

- You pay a royalty fee of 20% of the gross profits you derive from the use of Project Gutenberg-tm works calculated using the method

you already use to calculate your applicable taxes. The fee is owed to the owner of the Project Gutenberg-tm trademark, but he has agreed to donate royalties under this paragraph to the Project Gutenberg Literary Archive Foundation. Royalty payments must be paid within 60 days following each date on which you prepare (or are legally required to prepare) your periodic tax returns. Royalty payments should be clearly marked as such and sent to the Project Gutenberg Literary Archive Foundation at the address specified in Section 4, "Information about donations to the Project Gutenberg Literary Archive Foundation."

- You provide a full refund of any money paid by a user who notifies you in writing (or by e-mail) within 30 days of receipt that s/he does not agree to the terms of the full Project Gutenberg-tm License. You must require such a user to return or destroy all copies of the works possessed in a physical medium and discontinue all use of and all access to other copies of Project Gutenberg-tm works.
- You provide, in accordance with paragraph 1.F.3, a full refund of any money paid for a work or a replacement copy, if a defect in the electronic work is discovered and reported to you within 90 days of receipt of the work.
- You comply with all other terms of this agreement for free distribution of Project Gutenberg-tm works.

1.E.9. If you wish to charge a fee or distribute a Project Gutenberg-tm electronic work or group of works on different terms than are set forth in this agreement, you must obtain permission in writing from both the Project Gutenberg Literary Archive Foundation and Michael Hart, the owner of the Project Gutenberg-tm trademark. Contact the Foundation as set forth in Section 3 below.

1.F.

1.F.1. Project Gutenberg volunteers and employees expend considerable effort to identify, do copyright research on, transcribe and proofread public domain works in creating the Project Gutenberg-tm collection. Despite these efforts, Project Gutenberg-tm electronic

works, and the medium on which they may be stored, may contain "Defects," such as, but not limited to, incomplete, inaccurate or corrupt data, transcription errors, a copyright or other intellectual property infringement, a defective or damaged disk or other medium, a computer virus, or computer codes that damage or cannot be read by your equipment.

1.F.2. LIMITED WARRANTY, DISCLAIMER OF DAMAGES - Except for the "Right of Replacement or Refund" described in paragraph 1.F.3, the Project Gutenberg Literary Archive Foundation, the owner of the Project Gutenberg-tm trademark, and any other party distributing a Project Gutenberg-tm electronic work under this agreement, disclaim all liability to you for damages, costs and expenses, including legal fees. YOU AGREE THAT YOU HAVE NO REMEDIES FOR NEGLIGENCE, STRICT LIABILITY, BREACH OF WARRANTY OR BREACH OF CONTRACT EXCEPT THOSE PROVIDED IN PARAGRAPH 1.F.3. YOU AGREE THAT THE FOUNDATION, THE TRADEMARK OWNER, AND ANY DISTRIBUTOR UNDER THIS AGREEMENT WILL NOT BE LIABLE TO YOU FOR ACTUAL, DIRECT, INDIRECT, CONSEQUENTIAL, PUNITIVE OR INCIDENTAL DAMAGES EVEN IF YOU GIVE NOTICE OF THE POSSIBILITY OF SUCH DAMAGE.

1.F.3. LIMITED RIGHT OF REPLACEMENT OR REFUND - If you discover a defect in this electronic work within 90 days of receiving it, you can receive a refund of the money (if any) you paid for it by sending a written explanation to the person you received the work from. If you received the work on a physical medium, you must return the medium with your written explanation. The person or entity that provided you with the defective work may elect to provide a replacement copy in lieu of a refund. If you received the work electronically, the person or entity providing it to you may choose to give you a second opportunity to receive the work electronically in lieu of a refund. If the second copy is also defective, you may demand a refund in writing without further opportunities to fix the problem.

1.F.4. Except for the limited right of replacement or refund set forth in paragraph 1.F.3, this work is provided to you 'AS-IS' WITH NO OTHER WARRANTIES OF ANY KIND, EXPRESS OR IMPLIED, INCLUDING BUT NOT LIMITED TO WARRANTIES OF MERCHANTABILITY OR FITNESS FOR ANY PURPOSE.

1.F.5. Some states do not allow disclaimers of certain implied

warranties or the exclusion or limitation of certain types of damages. If any disclaimer or limitation set forth in this agreement violates the law of the state applicable to this agreement, the agreement shall be interpreted to make the maximum disclaimer or limitation permitted by the applicable state law. The invalidity or unenforceability of any provision of this agreement shall not void the remaining provisions.

1.F.6. INDEMNITY - You agree to indemnify and hold the Foundation, the trademark owner, any agent or employee of the Foundation, anyone providing copies of Project Gutenberg-tm electronic works in accordance with this agreement, and any volunteers associated with the production, promotion and distribution of Project Gutenberg-tm electronic works, harmless from all liability, costs and expenses, including legal fees, that arise directly or indirectly from any of the following which you do or cause to occur: (a) distribution of this or any Project Gutenberg-tm work, (b) alteration, modification, or additions or deletions to any Project Gutenberg-tm work, and (c) any Defect you cause.

Section 2. Information about the Mission of Project Gutenberg-tm

Project Gutenberg-tm is synonymous with the free distribution of electronic works in formats readable by the widest variety of computers including obsolete, old, middle-aged and new computers. It exists because of the efforts of hundreds of volunteers and donations from people in all walks of life.

Volunteers and financial support to provide volunteers with the assistance they need, are critical to reaching Project Gutenberg-tm's goals and ensuring that the Project Gutenberg-tm collection will remain freely available for generations to come. In 2001, the Project Gutenberg Literary Archive Foundation was created to provide a secure and permanent future for Project Gutenberg-tm and future generations. To learn more about the Project Gutenberg Literary Archive Foundation and how your efforts and donations can help, see Sections 3 and 4 and the Foundation web page at <http://www.pgla.org>.

Section 3. Information about the Project Gutenberg Literary Archive Foundation

The Project Gutenberg Literary Archive Foundation is a non profit 501(c)(3) educational corporation organized under the laws of the state of Mississippi and granted tax exempt status by the Internal Revenue Service. The Foundation's EIN or federal tax identification number is 64-6221541. Its 501(c)(3) letter is posted at <http://pglaf.org/fundraising>. Contributions to the Project Gutenberg Literary Archive Foundation are tax deductible to the full extent permitted by U.S. federal laws and your state's laws.

The Foundation's principal office is located at 4557 Melan Dr. S. Fairbanks, AK, 99712., but its volunteers and employees are scattered throughout numerous locations. Its business office is located at 809 North 1500 West, Salt Lake City, UT 84116, (801) 596-1887, email business@pglaf.org. Email contact links and up to date contact information can be found at the Foundation's web site and official page at <http://pglaf.org>

For additional contact information:

Dr. Gregory B. Newby
Chief Executive and Director
gbnewby@pglaf.org

Section 4. Information about Donations to the Project Gutenberg Literary Archive Foundation

Project Gutenberg-tm depends upon and cannot survive without wide spread public support and donations to carry out its mission of increasing the number of public domain and licensed works that can be freely distributed in machine readable form accessible by the widest array of equipment including outdated equipment. Many small donations (\$1 to \$5,000) are particularly important to maintaining tax exempt status with the IRS.

The Foundation is committed to complying with the laws regulating charities and charitable donations in all 50 states of the United States. Compliance requirements are not uniform and it takes a considerable effort, much paperwork and many fees to meet and keep up with these requirements. We do not solicit donations in locations

where we have not received written confirmation of compliance. To SEND DONATIONS or determine the status of compliance for any particular state visit <http://pglaf.org>

While we cannot and do not solicit contributions from states where we have not met the solicitation requirements, we know of no prohibition against accepting unsolicited donations from donors in such states who approach us with offers to donate.

International donations are gratefully accepted, but we cannot make any statements concerning tax treatment of donations received from outside the United States. U.S. laws alone swamp our small staff.

Please check the Project Gutenberg Web pages for current donation methods and addresses. Donations are accepted in a number of other ways including checks, online payments and credit card donations. To donate, please visit: <http://pglaf.org/donate>

Section 5. General Information About Project Gutenberg-tm electronic works.

Professor Michael S. Hart is the originator of the Project Gutenberg-tm concept of a library of electronic works that could be freely shared with anyone. For thirty years, he produced and distributed Project Gutenberg-tm eBooks with only a loose network of volunteer support.

Project Gutenberg-tm eBooks are often created from several printed editions, all of which are confirmed as Public Domain in the U.S. unless a copyright notice is included. Thus, we do not necessarily keep eBooks in compliance with any particular paper edition.

Most people start at our Web site which has the main PG search facility:

<http://www.gutenberg.org>

This Web site includes information about Project Gutenberg-tm, including how to make donations to the Project Gutenberg Literary

Archive Foundation, how to help produce our new eBooks, and how to subscribe to our email newsletter to hear about new eBooks.